

# DDR-66BT

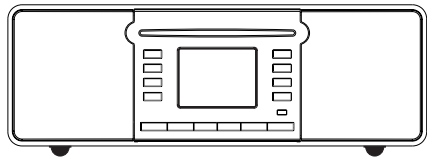

**GB**

Revision 1

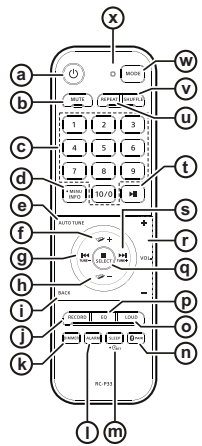
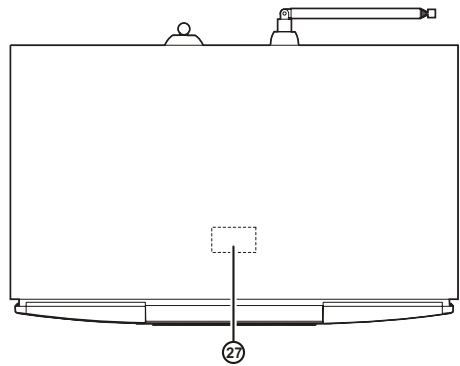
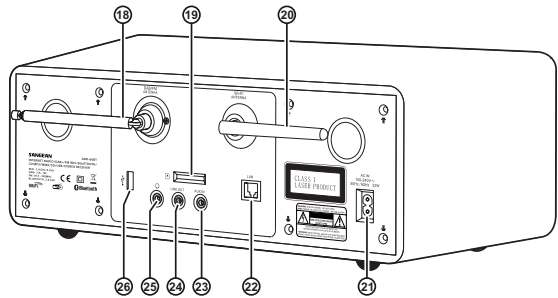
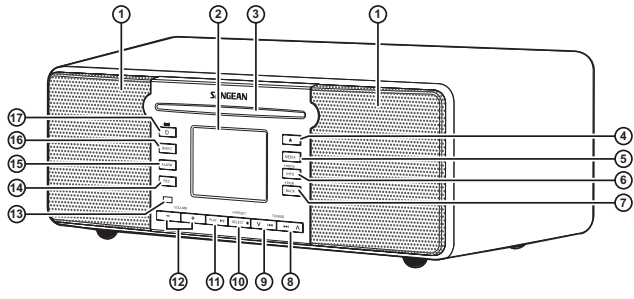



The Bluetooth® word mark and logos are registered trademarks owned by Bluetooth SIG, Inc. and any use of such marks by SANGEAN ELECTRONICS INC. is under license.

## Contents

### 1. IMPORTANT SAFETY INSTRUCTIONS ..... 04

### 2. Introduction ..... 04-07

Overview of the main unit and the remote control ..... 05-07

### 3. Getting started ..... 07-08

Finding a suitable location for the radio ..... 07

Preparing the remote control ..... 07

Connecting the radio to the mains power supply ..... 07

Performing the radio's initial setup ..... 07-08

Turning the radio on / off ..... 08

Selecting a playback source ..... 08

Using the radio's Main menu ..... 08

Using the MEDIA and RADIO buttons ..... 08

### 4. Controlling the radio using the UNDOK app ..... 08-09

Using the UNDOK app to control the radio . 08-09

Configuring the radio's settings using the UNDOK app ..... 09

### 5. Listening to Internet radio ..... 09-10

The Internet radio menu ..... 09-10

Storing Internet radio stations as presets ..... 10

Recalling Internet radio station presets ..... 10

Showing Internet radio information on the display ..... 10

### 6. Listening to Podcasts ..... 10-11

The Podcast menu ..... 10

Storing and recalling preset Podcasts ..... 10

Showing Podcast information on the display .. 11

### 7. Listening to streaming services ..... 11

Listening to Spotify ..... 11

Listening to Amazon Music ..... 11

Listening to Deezer ..... 11

### 8. Listening to DAB radio ..... 11-12

Tuning into DAB stations ..... 11

The DAB radio menu ..... 11-12

Showing DAB information on the display ..... 12

### 9. Listening to FM radio ..... 12-13

Tuning into FM stations ..... 12

The FM radio menu ..... 12

Showing FM information on the display ..... 12

Presetting stations in DAB and FM modes ..... 12-13

Recalling a preset in DAB and FM modes ..... 13

### 10. Listening to Bluetooth audio ..... 13-14

Pairing your Bluetooth device for the first time ..... 13

Audio playback in the Bluetooth mode ..... 13

Audio playback from a previously-paired Bluetooth device ..... 13

The Bluetooth menu ..... 14

Disconnecting your Bluetooth device ..... 14

Showing Bluetooth information on the display ..... 14

### 11. Listening to audio from CD ..... 14

Audio playback in the CD mode ..... 14

Showing CD information on the display ..... 14

### 12. Listening to audio from or recording audio to a USB device or SD card ..... 14-15

Playing files from a USB device or SD card ..... 14-15

Recording audio files to a USB device or SD card ..... 15

Showing track information on the display ..... 15

### 13. Listening to audio using the Aux in socket ..... 15

### 14. Using the System settings menu ..... 15-16

Manually setting the time and date ..... 16

### 15. Using the Main menu ..... 16-17

Setting the alarms ..... 17

Setting the sleep timer ..... 17

### 16. Product specifications ..... 18

GB

## 1. IMPORTANT SAFETY INSTRUCTIONS

1. Read these instructions.
2. Keep these instructions.
3. Heed all warnings.
4. Follow all instructions.
5. Do not use this apparatus near water.
6. Clean only with dry cloth.
7. Do not block any ventilation openings. Install in accordance with the manufacturer's instructions.
8. Do not install near any heat sources such as radiators, heat registers, stoves, or other apparatus (including amplifiers) that produce heat.
9. Do not defeat the safety purpose of the polarized or grounding-type plug. A polarized plug has two blades with one wider than the other.





A grounding type plug has two blades and a third grounding prong.

The wide blade or the third prong are provided for your safety. If the provided plug does not fit into your outlet. Consult an electrician for replacement of the obsolete outlet.

10. Protect the power cord from being walked on or pinched particularly at plugs, convenience receptacles, and the point where they exit from the apparatus.
11. Only use attachments / accessories specified by the manufacturer.
12. Use only with the cart, stand, tripod, bracket, or table specified by the manufacturer, or sold with the apparatus. When a cart is used, use caution when moving the cart / apparatus combination to avoid injury from tip-over. 
13. Unplug this apparatus during lightning storms or when unused for long periods of time.
14. Refer all servicing to qualified service personnel. Servicing is required when the apparatus has been damaged in any way, such as power-supply cord or plug is damaged. Liquid has been spilled or objects have fallen into the apparatus, the apparatus has been exposed to rain or moisture, does not operate normally, or has been dropped.
15. To Reduce the Risk of Fire or Electric Shock, Do not Expose This Appliance to Rain or Moisture.
16. The Shock Hazard Marking and Associated Graphical Symbol is provided on the rear of unit.
17. Apparatus shall not be exposed to dripping or splashing and no objects filled with liquids, shall be placed on the apparatus.
18. Excessive sound pressure on ear- and headphones could impair the hearing ability. Higher setting that idle on the equalizer leads to higher signal voltages on the output for ear and headphones.
19. The power plug should be close to the radio, and easy to be approached that during the emergency, to disconnect the power from the radio, just unplug the power plug from the AC power slot.

20. Where the MAINS plug or an appliance coupler is used as the disconnect device, the disconnected device shall remain readily operable.

21. To prevent possible hearing damage, do not listen at high volume levels for long periods. 

	The symbol indicates AC Voltage.
	The symbol indicates DC Voltage.
	The symbol indicates class II equipment.
	The lightning flash with arrowhead symbol, within an equilateral triangle, is intended to alert the user to the presence of uninsulated "dangerous voltage" within the product's enclosure that may be of sufficient magnitude to constitute a risk of electric shock to persons.
	The exclamation point within an equilateral triangle is intended to alert the user to the presence of important operating and maintenance (servicing) instructions

23. The mains plug / appliance inlet is used as the disconnect device, The socket-outlet shall be installed near the equipment and shall be easily accessible.

### CAUTION:

**These servicing instructions are for use by qualified service personnel only. To reduce the risk of the electric shock, do not perform any servicing other than that contained in the operating instructions unless you are qualified to so.**

## 2. Introduction

### Thank you

Thank you for purchasing the Sangean DDR-66BT radio. We hope you will be satisfied with your new radio and enjoy using it. This user manual will guide you through all the necessary steps to set up your DDR-66BT and will explain how to get the most out of your new radio.

### Your DDR-66BT





The DDR-66BT is a very versatile radio that allows you to:

- Listen to FM, DAB and Internet radio;
- Enjoy audio from several streaming services, compact disc, USB devices, SD card, Bluetooth devices and other devices that feature an audio output;
- Set alarms in order to use the radio as an alarm clock;
- Fall asleep listening to audio using a sleep timer;

Before using this device, please make sure to read and understand all parts of the manual.

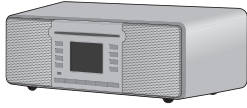
### What's in the box

Check and confirm that all of the following parts are included in the box:

Main unit	
AC power cord	
Remote control	
Quick Start Guide	

## Overview of the main unit and the remote control

- ① Left and right speaker
- ② LCD Display
- ③ CD slot
- ④ CD eject button (▲)
  - Press to eject the CD from the CD slot.
- ⑤ MEDIA button
  - Press repeatedly to switch to the USB, SD, CD or Bluetooth mode.
- ⑥ INFO / MENU button
  - Press to cycle through information from the playback source on the radio's display.
  - Press and hold to open the menu for the current mode.
- ⑦ BACK / Bluetooth pair button
  - Press to go back one step in the radio's menus.
  - While in Bluetooth mode, press and hold to switch to the Bluetooth pairing mode.
- ⑧ Tuning up / Next track / Fast forward button (▶▶/▲)
  - Press to increase the frequency in the FM radio mode.
  - Press to go to the next track in the USB, SD, CD, Bluetooth, Spotify modes.
  - Press to navigate in menus.
  - Press and hold to auto scan to the next station with a higher frequency in the FM radio mode.
  - Press and hold to fast forward in the USB, SD, CD, Bluetooth modes.
- ⑨ Tuning down / Previous track / Rewind button (◀◀/▼)
  - Press to decrease the frequency in the FM radio mode.
  - Press to go to the start of the track or the previous track in the USB, SD, CD, Bluetooth, Spotify modes.
  - Press to navigate in menus.
  - Press and hold to auto scan to the next station with a lower frequency in the FM radio mode.
  - Press and hold to fast rewind in the USB, SD, CD, Bluetooth modes.
- ⑩ SELECT / Stop button (■) / Preset button
  - Press to stop playback in the USB, SD, CD modes.
  - Press to open / select an item in the radio's menus.
  - Press to enter the "Recall from Preset" menu in the DAB / FM radio, Internet radio and Podcasts modes.
  - Press and hold to enter the "Save to Preset" menu in the DAB / FM radio, Internet radio and Podcasts modes.
- ⑪ PLAY / Pause button (▶||)
  - Press to start playback or to pause / resume playback.
- ⑫ VOLUME up / down button
  - Press VOLUME + to increase volume.
  - Press VOLUME - to decrease volume.
- ⑬ Remote control sensor
  - Infrared sensor for receiving remote control input.
- ⑭ Record button
  - Press to record the radio's audio output to a USB device or SD card.
- ⑮ ALARM button
  - While the radio is powered on, press to go to the radio's alarm menu.
  - While the radio is in standby mode, press repeatedly to enable / disable the radio's alarms.
- ⑯ RADIO button
  - Press repeatedly to select the Internet radio, Podcasts, Spotify, Amazon Music, Deezer, DAB radio, FM radio or AUX in mode.
- ⑰ Power button (⏻) / Sleep button
  - Press to turn the radio on / off.
  - Press and hold to enter the sleep timer setting and then set the sleep timer using the Tuning up / down buttons.
- ⑱ DAB / FM antenna
  - Extend and position this antenna to improve reception in the DAB and FM modes.
- ⑲ SD card slot
  - Insert an SD card to playback audio from the SD card or to record audio to the SD card.
- ⑳ Wi-Fi antenna

- Position this antenna correctly to improve the radio's Wi-Fi reception.

**21** AC IN socket

- AC IN socket for AC power cord (100-240V ~ 50/60 Hz, 32W)

**22** LAN Ethernet port

- Connect an Ethernet cable to connect the radio to a Local Area Network.

**23** AUX IN socket

- 3.5mm socket for audio input from external device.

**24** LINE OUT socket

- 3.5mm socket for audio output to an external device.

**25** Headphones socket

- 3.5mm socket for stereo audio output to headphones or earphones.

**26** USB port

- Insert or connect an external USB device to playback audio in the USB mode or record audio to the USB device.

**27** NFC detection area

## Remote control

**a** Power button (  )

- Press to turn the radio on / off.

**b** MUTE button

- Press to mute / unmute the radio's audio output.

**c** Numeric buttons

- Press to select a track number or preset number.
- Press and hold to store the currently playing radio station as a preset.

**d** INFO / MENU button

- Press to cycle through information from the playback source on the radio's display.
- Press and hold to open the menu for the current mode.

**e** AUTO TUNE button

- Press to perform a full scan in the DAB radio mode.
- Press to scan for the next station in the FM radio mode.

**f** Folder up button

- Press to navigate in menus.
- Press to go to the next preset.
- Press to go to the next folder in the USB, SD, CD modes.

**g** Tuning down / Previous track / Rewind button (  / Tune- )

- Press to decrease the frequency in the FM radio mode.
- Press to go to the start of the track or the previous

track in the USB, SD, CD, Bluetooth, Spotify modes.

- Press to navigate in menus.

- Press and hold to auto scan to the next station with a lower frequency in the FM radio mode.

- Press and hold to fast rewind in the USB, SD, CD, Bluetooth modes.

**h** Folder down button

- Press to navigate in menus.

- Press to go to the previous preset.

- Press to go to the previous folder in the USB, SD, CD modes.

**i** BACK button

- Press to go back one step in the radio's menus.

**j** RECORD button

- Press to record the radio's audio output to a USB device or SD card.

**k** DIMMER button

- Press repeatedly to adjust the brightness of the radio's backlight.

**l** ALARM button

- While the radio is powered on, press to go to the radio's alarm menu.
- While the radio is in standby mode, press repeatedly to enable / disable the radio's alarms.

**m** SLEEP button

- Press repeatedly to set the radio's sleep timer.

**n** Bluetooth pair button

- Press to switch to the Bluetooth pairing mode.

**o** Loudness button

- Press to enable / disable the radio's loudness feature.

**p** EQ button

- Press open the EQ menu and to select an EQ mode.

**q** SELECT / Stop button (  )

- Press to stop playback in the USB, SD, CD modes.
- Press to open / select an item in the radio's menu.
- Press to enter the "Recall from Preset" menu in the DAB / FM radio, Internet radio and Podcasts modes.
- Press and hold to enter the "Save to Preset" menu in the DAB / FM radio, Internet radio and Podcasts modes.

**r** Volume up / down button

- Press VOL. + to increase volume.
- Press VOL. - to decrease volume.

**s** Tuning up / Next track / Fast forward button (  / Tune+ )

- Press to increase the frequency in the FM radio

mode.

- Press to go to the next track in the USB, SD, CD, Bluetooth, Spotify modes.
- Press to navigate in menus.
- Press and hold to auto scan to the next station with a higher frequency in the FM radio mode.
- Press and hold to fast forward in the USB, SD, CD, Bluetooth modes.

**t** Play / Pause button (▶||)

- Press to start playback or to pause / resume playback.

**u** REPEAT button

- Repeatedly press the REPEAT button to cycle through the available repeat modes (repeat one, repeat all, repeat folder and repeat intro) in the USB, SD, CD modes. The icon of the selected repeat mode is shown at the bottom of the radio's display.

**v** SHUFFLE button

- Repeatedly press the SHUFFLE button to enable / disable the shuttle feature in the USB, SD, CD modes. If shuffle is enabled, the shuffle icon is shown at the bottom of the radio's display.

**w** MODE button

- Press repeatedly to select the desired mode.

**x** Infrared LED

- Lights up when the remote control is sending a command to the radio.

**Note:**

**All instructions in the manual use the controls on the radio itself. If you would want to use the remote control instead, use the corresponding buttons on the remote control instead. Some features, such as the mute feature and setting the repeat / shuffle mode can only be controlled using the remote control.**

### 3. Getting started

Follow the instructions in this chapter to get your DDR-66BT up and running in no time.

#### Finding a suitable location for the radio

After unpacking the radio from the box, take the following guidelines into account when finding a suitable location for the radio:

- Place the radio on a flat, even surface such as a table.
- Do not place the radio near heat sources.
- Make sure there is sufficient space available around the radio for proper ventilation.
- If you are planning to connect the radio to your Wi-Fi network, make sure to place the radio in a location where Wi-Fi reception is good.
- Avoid placing the radio near appliances that can interfere with Wi-Fi reception, such as microwaves.

#### Preparing the remote control

The radio's remote control requires two AAA batteries to

operate. To place the batteries:

1. Open the battery compartment on the back of the remote control.
2. Insert two AAA batteries in the battery compartment with polarities as shown in the diagram inside the battery compartment.
3. Close the battery compartment again.

#### Connecting the radio to the mains power supply

The DDR-66BT can be powered using the supplied AC power cord. Before connecting the plug of the AC power cord to a wall socket, please ensure that the voltage that the wall socket supplies is within the supported range printed at the back of the radio (100-240 V ~ 50/60 Hz).

If this is the case, first connect the connector of the power cord to the radio and then insert the plug of the power cord into the wall socket.

GB

#### Performing the radio's initial setup

After your DDR-66BT has been supplied with power for the first time, it will automatically turn on. While the radio is starting up, "SANGEAN" will be shown on the radio's display. When the software is loaded the radio's Setup Wizard will automatically be started.

The radio's Setup Wizard will give you a link to the privacy policy and guide you through the configuration of the radio time format and the radio's network connection.

1. When the Setup Wizard is displayed, it will first show a link to the privacy policy in relation to the use of the radio. Before using the radio, make sure to read the privacy policy and use the radio's online functionality only if you agree to the privacy policy. Press the SELECT / ■ button if you agree to the privacy policy.
2. Next the radio will ask if you want to start the Setup Wizard now. Use the V / ◀◀ and ▶▶ / ▲ buttons to select [Yes] or [No] and press the SELECT / ■ button to confirm your choice. Select [Yes] to proceed with the Setup Wizard or select [No] to directly go to the radio's Main menu without configuring the radio's time format and network connection.
3. After selecting [Yes], the radio's display will show "12 / 24 hour format". Use the V / ◀◀ and ▶▶ / ▲ buttons to select the desired time format and press the SELECT / ■ button to confirm your choice.
4. Next, the auto update list is shown on the radio's display.

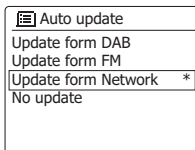

- **[Update from DAB]:** Synchronize the radio's time and date using DAB stations.
- **[Update from FM]:** Synchronize the radio's time and date using FM stations.
- **[Update from Network]:** Synchronize the radio's time and date using a network connection.
- **[No update]:** Time and date will not be synchronized

and has to be set manually.

5. After selecting the auto update method, the radio will ask if you want to keep the radio connected to the network when the radio is in the standby mode. Use the V / I◀◀ and ▶▶ / A buttons to select **[Yes]** or **[No]** and press the SELECT / ■ button to confirm your choice.

6. The Network Wizard will now scan for networks and show a list of Wi-Fi networks that are detected by the radio along with several other options.

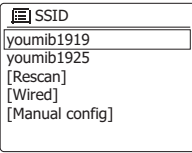

Use the V / I◀◀, ▶▶ / A and SELECT / ■ buttons to select one of the options:

- **[Name of a Wi-Fi network]:** Select the name of a Wi-Fi network to proceed to the password entry screen for the selected network.
- **[Rescan]:** Select this option to scan for Wi-Fi networks again.
- **[Wired]:** Select this option if you have connected the radio to a LAN using an Ethernet cable (not included).
- **[Manual config]:** Select this option to manually configure the radio's internet connection (wired / wireless, DHCP enabled / disabled, IP address / subnet mask, SSID, authentication method and password).

7. You have now completed the Setup Wizard and are ready to start using your DDR-66BT. After completing the Setup Wizard, the radio's Main menu will be shown on the display.

#### Notes:

- All of the radio's menus can be navigated by selecting an option using the V / I◀◀ and ▶▶ / A buttons and by pressing the SELECT / ■ button to open or select an item.
- During the Setup Wizard, the radio's default and recommended settings are indicated using an asterisk.
- In order to use any of the radio's internet features or to control the radio using the UNDOK app, the radio must be connected to a network that has internet access.

### Turning the radio on / off

The DDR-66BT can be switched on or off by pressing the Power button. After the radio is turned on, it will automatically select the last used source.

### Selecting a playback source

There are two ways to select a playback source:

#### Using the radio's Main menu

- Open the radio's Main menu by pressing and holding the INFO / MENU button and then select the option **[Main menu]** using the V / I◀◀, ▶▶ / A and SELECT / ■ buttons (refer to chapter 15 "Using the Main menu" for details regarding the radio's Main menu).
- Next, select the playback source using the V / I◀◀ or ▶▶ / A button and press the SELECT / ■ button to confirm your choice.

### Using the MEDIA and RADIO buttons

- Repeatedly press the MEDIA button to select the CD, USB, SD or Bluetooth mode.
- Repeatedly press the RADIO button to select the Internet Radio, Podcasts, Spotify, Amazon Music, Deezer, DAB radio, FM radio or AUX in mode.

## 4. Controlling the radio using the UNDOK app

Aside from controlling your DDR-66BT with the buttons on the radio or the remote control, it can also be controlled from a smart device using the UNDOK app. The UNDOK app offers an intuitive and easy to use user interface, allows you to configure many of the radio's settings and is available for Android and iOS.



UNDOK

### Using the UNDOK app to control the radio

Follow these steps to use the UNDOK app to control the radio:

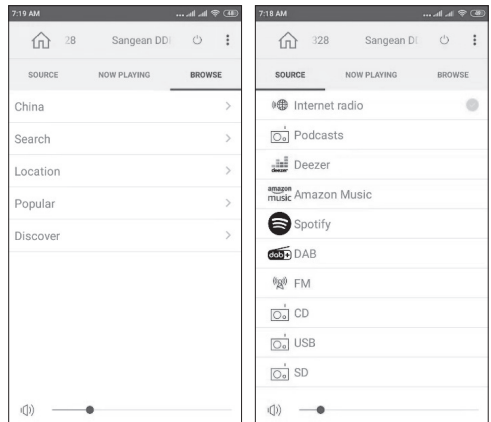
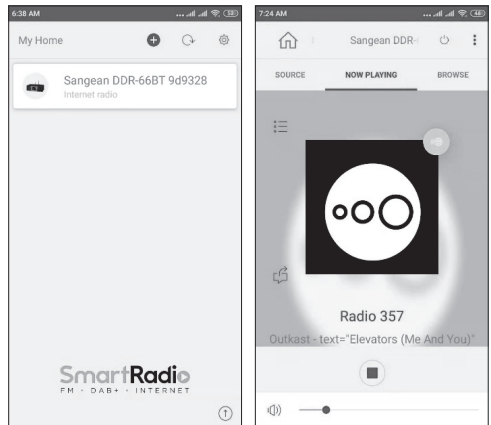

1. Download and install the UNDOK app for your device by searching for "UNDOK" in Apple's App Store or the Google Play Store.

2. Make sure the radio and your smart device are connected to the same network. Instructions for connecting the radio to your network can be found in the "Performing the radio's initial setup" section of chapter 3 "Getting started".

3. Open the UNDOK app on your smart device.

After starting the UNDOK app, your DDR-66BT should appear on the home screen of the app with the name "DDR-66BT xxxxxx" (the 6 digit alphanumeric code are the last 6 digits of your radio's MAC address).

4. Connect to the radio by tapping on it.

5. Select the "Source" tab in the upper left corner to select the radio's playback source.

6. Select the "Browse" tab in the upper right corner to browse through content for the selected source.

7. Playback, tuning and volume can be controlled using the controls in the app.

**Notes:**

- **If your DDR-66BT is not connected to your network before starting the UNDOK app, the app itself can also be used to connect your radio to the network. Follow the on-screen instructions to complete connecting the radio to the network.**
- **These instructions and screenshots are based on the Android version of the UNDOK app for smartphones. If you are using a different type of device, the screen layout and / or icons may be slightly different.**

**Configuring the radio's settings using the UNDOK app**

Follow these steps to configure the radio's settings using the UNDOK app:

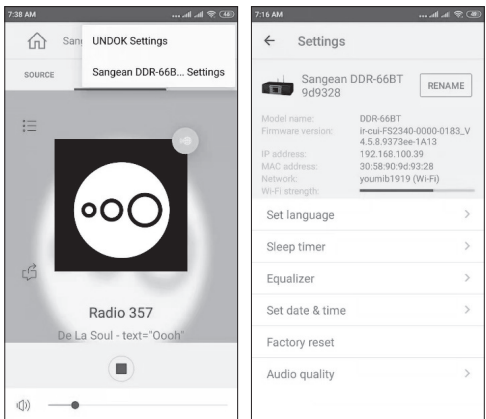

1. Start the UNDOK app on your smart device and connect to the radio as previously described.
2. Tap the three dots icon in the upper right corner of the screen and select "Sangean DDR-66B... Settings".
3. The radio's settings that can be configured using the UNDOK app now appear on the smart device's screen. To configure any setting, simply tap it and set it to the

desired value.

**Note:**

**These instructions and screenshots are based on the Android version of the UNDOK app for smartphones. If you are using a different type of device, the screen layout and / or icons may be slightly different.**

**5. Listening to Internet radio**

The DDR-66BT is capable of receiving tens of thousands of internet stations from around the world when the radio is connected to the internet via Wi-Fi or an Ethernet connection.

**To listen to Internet radio, follow these steps**

1. Turn on the radio using the Power button.
2. Select the Internet radio mode by repeatedly pressing the RADIO button or using the radio's Main menu.

GB

3. If the Internet radio mode is being used for the first time, the Internet station selection menu is displayed on the radio's display.

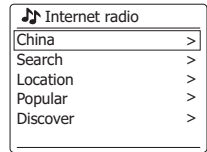

Select one of the options to tune into an Internet radio station:

- **[Your country]:** Select this option to tune into Internet radio stations from your country ("China" in the image above). After selecting this option, you can choose to tune into local Internet radio stations or popular radio stations from your country, or to search for Internet radio stations from your country based on a genre or a city.
- **[Search]:** Select this option to search for an Internet radio station by name. After selecting this option, use the V / ◀▶ / ▲ and SELECT / ■ buttons to input the search keyword.
- **[Location]:** Select this option to find and tune into Internet radio stations by location. Locations from all around the world can be selected in this submenu.
- **[Popular]:** Select this option to tune into popular Internet radio stations from around the world.
- **[Discover]:** Select this option to filter Internet radio stations by origin, genre and language.

4. After selecting a radio station using one of the options described above, the radio will tune into and start playing the selected station.
5. When listening to an Internet radio station, press the PLAY / ▶|| button to stop / resume playback.

**The Internet radio menu**

You can open the Internet radio menu by pressing and holding the INFO / MENU button while the radio is in the Internet radio mode.

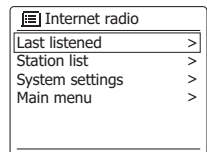

The Internet radio menu offers the following options:

- **[Last listened]:** Select this option to view a list of the last Internet radio stations and Podcasts you've tuned into previously.
- **[Station list]:** Select this option to go to the internet station selection menu described in the previous section.
- **[System settings]:** Select this option to go to the System settings menu and configure the radio (refer to chapter 14 "Using the System settings menu" for details).
- **[Main menu]:** Select this option to go back to the Main menu, where you can switch to any of the radio's modes or set the radio's alarms or sleep timer, or go to the System settings menu (refer to chapter 15 "Using the Main menu" for details).

## Storing Internet radio stations as presets

Your DDR-66BT can store up to 10 Internet radio stations or Podcasts as presets. Presets can be recalled quickly without having to go through most of the radio's menus.

Follow these steps to store an Internet radio station as a preset station:

1. Turn on the radio, select the Internet radio mode and tune into an Internet radio station as previously described.
2. Press and hold the SELECT / ■ button.
3. The Save to preset screen appears. Select the preset under which you want to save the Internet radio station using the V / I◀◀ or ▶▶ / Λ button and press the SELECT / ■ button to save the station under the chosen preset number. If another Internet radio station or Podcast has already been stored under the chosen preset number, that station or Podcast will be overwritten.
4. After pressing the SELECT / ■ button, the display will show the message "Preset stored" to indicate the preset has been successfully stored under the chosen preset number.

## Recalling Internet radio station presets

While the radio is in the Internet radio or Podcast mode and the menu is not being displayed:

1. Press the SELECT / ■ button.
2. Select a preset number using the V / I◀◀ or ▶▶ / Λ button and press the SELECT / ■ button to confirm your choice.
3. The radio will now tune into the selected preset.

## Showing Internet radio information on the display

When listening to an Internet radio station, repeatedly press the INFO / MENU button to cycle through the following information on the radio's display:

- Artist & track name
- Slogan & Description of station
- Language & Location
- Bit rate & Sampling rate

- Playback buffer
- Today's date

## 6. Listening to Podcasts

The DDR-66BT is also capable of tuning into many different Podcasts from around the world.

### To listen to Podcasts, follow these steps

1. Turn on the radio using the Power button.
2. Select the Podcasts mode by repeatedly pressing the RADIO button or using the radio's Main menu.

3. If the Podcasts mode is being used for the first time, the Podcast selection menu is displayed on the radio's display.

Podcasts	
China	>
COVID-19	>
Search	>
Location	>
Discover	>

Select one of the options to tune into a Podcast:

- **[Your country]:** Select this option to tune into Podcasts from your country ("China" in the image above). After selecting this option, you can choose to tune into local Podcasts, popular Podcasts or search for Podcasts from your country by genre.
  - **[A hot topic]:** Select this option to tune into Podcasts related to a topic that is currently popular ("COVID-19" in the image above). This topic will change from time to time, depending on what's hot at the moment and your time zone / region.
  - **[Search]:** Select this option to search for a Podcast by name. After selecting this option, use the V / I◀◀ , ▶▶ / Λ and SELECT / ■ buttons to input the search keyword.
  - **[Location]:** Select this option to find and tune into Podcasts by location. Locations from all around the world can be selected in this submenu.
  - **[Discover]:** Select this option to filter Podcasts by origin, genre and language.
4. After selecting a Podcast using one of the options described above, the radio will tune into and start playing the selected Podcast.
  5. When listening to a Podcast, press the PLAY / ▶▶ button to pause / resume playback.

### The Podcast menu

The Podcast menu is identical to the Internet radio menu described previously, but instead of the option **[Station list]** it has the option **[Podcast list]**, which takes you back to the Podcast selection menu.

### Storing and recalling preset Podcasts

As mentioned previously, both Internet radio stations and Podcasts can be saved in the same preset list and recalled in the same manner. Refer to the sections "Storing Internet radio stations as presets" and "Recalling Internet radio station presets" in the previous chapter for details.

## Showing Podcast information on the display

When listening to a Podcast, repeatedly press the INFO / MENU button to cycle through the following information on the radio's display:

- Track name
- Track description
- Artist
- Album
- Bit rate & Sampling rate
- Playback buffer
- Today's date

## 7. Listening to streaming services

The DDR-66BT can also be used to listen to audio from the streaming services Spotify, Amazon Music and Deezer. If you have a premium account for any of these services, follow the instructions below to connect the radio to the audio steaming service of your choice.

### Listening to Spotify

The Spotify Software is subject to third party licenses found here:



<https://www.spotify.com/connect/third-party-licenses>

Use your phone, tablet or computer as a remote control for Spotify. Go to [spotify.com/connect](https://www.spotify.com/connect) to learn how.

### Listening to Amazon Music

If you want to play Amazon Music audio through the radio, follow these steps:

1. Turn on the radio using the Power button.
2. Select the Amazon Music mode by repeatedly pressing the RADIO button or using the radio's Main menu.
3. Use the UNDOK app (refer to chapter 4 "Controlling the radio using the UNDOK app" for more information) to connect to and log in to Amazon Music.
4. Control playback using the control app or the buttons on the radio.

More information about Amazon Music can be found at <https://music.amazon.com>.

### Listening to Deezer

If you want to play Deezer music through the radio, follow these steps:

1. Turn on the radio using the Power button.
2. Select the Deezer mode by repeatedly pressing the RADIO button or using the radio's Main menu.
3. Login to Deezer by entering your username and password using the V / I◀◀, ▶▶I / Λ and SELECT / ■ buttons.
4. Use the radio's menu and buttons to control playback.

More information about Deezer can be found at <https://www.deezer.com/>.

## 8. Listening to DAB radio

### Tuning into DAB stations

To tune into DAB radio stations, follow these steps:

1. Turn on the radio using the Power button.
2. Select the DAB radio mode by repeatedly pressing the RADIO button or using the radio's Main menu.
3. If this is the first time the DAB radio mode is being used, the radio will automatically perform a full scan in order to find all available DAB radio stations. During the scanning process, as new stations are detected the station counter will increase and the stations will be added to the list which is stored in the radio. The bar graph indicates the progress of the scan.
4. When scanning is completed, the radio will list all stations that were found. Use the V / I◀◀ or ▶▶I / Λ buttons to scroll through the list of stations and press the SELECT / ■ button to tune into a station.

**Note:**

**Before selecting the DAB radio mode and performing a scan, make sure the DAB / FM antenna at the back of the radio is fully extended and the radio's reception is good.**

### The DAB radio menu

You can open the DAB radio menu by pressing and holding the INFO / MENU button while the radio is in the DAB radio mode.

DAB	
Station list	>
Scan	>
Manual tune	>
Prune invalid	>
DRC	>

The DAB radio menu offers the following options:

- **[Station list]:** Select this option display all DAB radio stations that were found and tune into one of the stations. If no stations were previously found, the radio will perform a new full scan.
- **[Scan]:** Select this option to perform a full scan and store all DAB radio stations that were found in the station list.
- **[Manual tune]:** Select this option to manually tune into a DAB channel / frequency.
- **[Prune invalid]:** Select this option to delete all unavailable stations from the station list.
- **[DRC]:** Dynamic Range Control (also known as DRC) can make quieter sounds easier to hear when your radio is used in a noisy environment by reducing the dynamic range of the audio signal.

Select this option and then use the V / I◀◀ or ▶▶I / Λ button to highlight the required DRC setting:

**[DRC high]:** DRC is set as sent by broadcaster.

**[DRC low]:** DRC level is set to 1 / 2 that sent by broadcaster.

**[DRC off]:** DRC is switched off. Broadcast DRC will be ignored. This is the default setting.

Press the SELECT / ■ button to confirm the setting.

- **[Station order]:** Select this option and subsequently **[Alphanumeric]** to sort the station list alphanumerically

GB

or select **[Ensemble]** to sort the station list by DAB multiplex.

- **[System settings]:** Select this option to go to the System settings menu and configure the radio (refer to chapter 14 "Using the System settings menu" for details).
- **[Main menu]:** Select this option to go back to the Main menu, where you can switch to any of the radio's modes or set the radio's alarms or sleep timer, or go to the System settings menu (refer to chapter 15 "Using the Main menu" for details).

### Showing DAB information on the display

When listening to a DAB radio broadcast, repeatedly press the INFO / MENU button to cycle through the following information on the radio's display:

- Text
- Program type
- Multiplex name & Frequency
- Signal error & Strength
- Bit rate & Audio type
- Today's date

If the broadcast being received is in stereo, then the stereo speaker icon will be shown at the bottom of the radio's display. If the currently tuned station has been stored as a preset, then the preset number will also be shown.

## 9. Listening to FM radio

### Tuning into FM stations

To tune into FM radio stations, follow these steps:

1. Turn on the radio using the Power button.
2. Select the FM radio mode by repeatedly pressing the RADIO button or using the radio's Main menu.
3. Press and hold the V / I◀◀ or ▶▶ / Λ button to automatically tune into an FM station with a lower or higher frequency respectively. Your radio will stop scanning when it finds a station of sufficient strength. The display will show the frequency of the signal which has been found and at the bottom of the display a signal strength icon will be shown to indicate the strength of the signal received. If RDS information is available, the RDS icon will also be shown at the bottom of the radio's display and after a few seconds the display will show the radio station name.
4. Press the V / I◀◀ or ▶▶ / Λ button to fine-tune the frequency with steps of 0.05 MHz if needed.
5. Repeat the steps 3 and 4 to tune into other radio stations.

#### Note:

**Before selecting the FM radio mode and tuning into stations, make sure the DAB / FM antenna at the back of the radio is fully extended and the radio's reception is good.**

### The FM radio menu

You can open the FM radio menu by pressing and holding the INFO / MENU button while the radio is in the FM radio mode.

FM	
Scan setting	
Audio setting	
System settings	>
Main menu	>

The FM radio menu offers the following options:

- **[Scan setting]:** Select this option to configure if the radio should only look for strong signals or all signals when using the automatic tuning feature (by holding the V / I◀◀ or ▶▶ / Λ button).
- **[Audio setting]:** Select this option to configure if the radio should only play FM stations in mono. Forcing the radio to play FM broadcasts in mono can help reduce noise when listening to FM broadcasts.
- **[System settings]:** Select this option to go to the System settings menu and configure the radio (refer to chapter 14 "Using the System settings menu" for details).
- **[Main menu]:** Select this option to go back to the Main menu, where you can switch to any of the radio's modes or set the radio's alarms or sleep timer, or go to the System settings menu (refer to chapter 15 "Using the Main menu" for details).

### Showing FM information on the display

When listening to a FM radio station that is also broadcasting RDS data (the RDS icon is shown on the radio's display), repeatedly press the INFO / MENU button to cycle through the following information on the radio's display:

- Text message
- Program type
- Frequency
- Today's date

If no RDS information is available, the radio will be unable to display the text message and program type. If the stereo speaker icon is shown at the bottom of the radio's display, this indicates that the radio is receiving a stereo broadcast.

### Presetting stations in DAB and FM modes

There are 10 memory presets each for DAB and FM radio. They are used in the same way for each operating mode.

1. Turn on the radio, then select the DAB or FM radio mode and Tune to the required radio station as previously described.
2. Press and hold the SELECT / ■ button. The display will show a "Save to Preset" menu.
3. Press the V / I◀◀ or ▶▶ / Λ button to select the required Preset number. Then press the SELECT / ■ button to store the preset station. "Preset stored" will be shown on the display indicating the station is stored under the selected preset number. If another station has already been stored under the chosen preset number, that station will be overwritten.
4. Alternatively, to store the currently playing radio station as a preset, press and hold the required Preset button

(1-10) on the remote control until the display shows "Preset stored". The station will be stored under the chosen preset button. Repeat this procedure as needed for the remaining presets.

### Recalling a preset in DAB and FM modes

1. Turn on the radio and then select the DAB or FM radio mode using the RADIO button or using the radio's Main menu.
2. Press the SELECT / ■ button to display the "Recall from Preset" menu.
3. Select a preset number using the V / ◀ or ▶ / ▸ button and press the SELECT / ■ button to confirm your choice. The radio will now tune into the selected preset. The chosen preset number is also shown in the lower area of the radio display.
4. Alternatively, momentarily press the required Preset button on the remote control. Your radio will then tune to the station stored in the selected preset memory.

## 10. Listening to Bluetooth audio

In order to stream Bluetooth music to your radio, you need to pair your Bluetooth device with the DDR-66BT. Pairing creates a 'bond' so two devices can recognize each other.

### Pairing your Bluetooth device for the first time

1. Turn on the radio using the Power button.
2. Select the Bluetooth mode by repeatedly pressing the MEDIA button or using the radio's Main menu. After selecting the Bluetooth mode, the radio's display will show "No connect".
3. Activate Bluetooth on your Bluetooth device (refer to the manual of the Bluetooth device if you are unsure about how to activate Bluetooth).
4. Go to the Bluetooth list on your Bluetooth device and select the device named "DDR-66BT" (if you have changed the name of the radio in the radio's System settings menu, search for the name you have given the radio instead).

#### Note:

**On some Bluetooth devices with Bluetooth version 2.1 or earlier, you might be requested to enter a passcode. If this is the case, enter the passcode "0000".**

5. After the devices have paired and connected, a confirmation tone will be played on the radio and the radio's display will show the name of the connected Bluetooth device and the playback status. You can now play music on your Bluetooth device and stream the music through the radio's speakers.

#### Notes:

- If your Bluetooth device is equipped with NFC, it is also possible to pair the device by enabling NFC and tapping the Bluetooth device's NFC area against the NFC area on the radio.
- If 2 Bluetooth devices are pairing for the first time, both must search for your radio, it will show its availability on both devices. However, if one device links with this unit first, then the other Bluetooth device won't find it on the list.

- If you take your Bluetooth device out of range, the connection between your device and the radio will be temporarily disconnected. Your radio will automatically reconnect if the Bluetooth device is brought back into range. Be aware that during the period of disconnection, no other Bluetooth device can pair or link with your radio.

- If "DDR-66BT" shows up in your Bluetooth device list, but your Bluetooth device cannot connect with it, please delete the item from your list and pair the Bluetooth device with the radio again following the steps described previously.

- The effective operation range between the radio and the paired Bluetooth device is approximately 10 meters (30 feet). Any obstacle between the system and the device can reduce the operational range.

- Bluetooth connectivity performance may vary depending on the connected Bluetooth device. Please refer to the Bluetooth capabilities of your device before connecting it to your radio. Not all features may be supported, depending on the Bluetooth device used.

- With some mobile phones, making / receiving calls, text messages, e-mails or any other activities unrelated to audio streaming may mute the Bluetooth audio streaming or even temporarily disconnect from your device. Such behavior is a function of the Bluetooth device and does not indicate a problem with your DDR-66BT.

### Audio playback in the Bluetooth mode

When you have successfully connected your radio with the chosen Bluetooth device you can start to play your music using the controls on the radio or your connected Bluetooth device.

1. Once playback has started, the updated playback status "Playing" will be shown on the display.
2. The volume can be adjusted both on the radio using the VOLUME + and - buttons and on the Bluetooth device using the volume control of the device.
3. Playback can be controlled both on the radio and on the Bluetooth device as well. Press the PLAY / ▶ button to start playing audio or to pause / resume playback. Press the V / ◀ or ▶ / ▸ / ▲ button to go to the previous or next track and hold the V / ◀ or ▶ / ▸ / ▲ to fast forward or fast rewind within a track.

#### Note:

**Not all player applications or devices may respond to all of these controls.**

### Audio playback from a previously-paired Bluetooth device

The DDR-66BT can memorize up to 8 sets of paired Bluetooth devices, when the memory exceed this amount, the earliest device with which the radio was paired will be overwritten in the radio's memory.

If your Bluetooth device has previously paired with the DDR-66BT previously, the radio will still remember your Bluetooth device and attempt to reconnect with the device that was last connected. If the last connected Bluetooth device is not available, the radio will try to connect to the second last Bluetooth device.

## The Bluetooth menu

You can open the Bluetooth menu by pressing and holding the INFO / MENU button while the radio is in the Bluetooth mode.

The Bluetooth menu offers the following options:

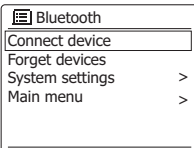

- **[Connect device]:** Select this option to disconnect from the currently connected Bluetooth device and switch the radio back to the Bluetooth pairing mode.
- **[Forget devices]:** Select this option to have the radio forget all devices it has previously paired with.
- **[System settings]:** Select this option to go to the System settings menu and configure the radio (refer to chapter 14 "Using the System settings menu" for details).
- **[Main menu]:** Select this option to go back to the Main menu, where you can switch to any of the radio's modes or set the radio's alarms or sleep timer, or go to the System settings menu (refer to chapter 15 "Using the Main menu" for details).

## Disconnecting your Bluetooth device

To disconnect your Bluetooth device, either turn off Bluetooth on the Bluetooth device, press and hold the BACK / Bluetooth pair button on the radio, open the Bluetooth menu and select **[Connect device]** to switch back to the Bluetooth pairing mode or switch to another mode on the radio by pressing either the RADIO or MEDIA button or by using the radio's Main menu. If you disconnect the Bluetooth device when the radio is in the Bluetooth mode, the radio's display will show "No connect" and the radio will be available for pairing again.

## Showing Bluetooth information on the display

When listening to Bluetooth audio, repeatedly press the INFO / MENU button to cycle through the following information on the radio's display:

- Album
- Artist
- Title

## 11. Listening to audio from CD

The DDR-66BT is capable of playing CDs, CD-Rs and CD-RWs and can play both normal audio CDs and CDs with MP3 and WMA files (with the exception of files encoded using WMA lossless, WMA Voice, WMA 10 professional and files with DRM protection).

**Note:** This unit supports standard 120 mm CDs only.

### Audio playback in the CD mode

1. Turn on the radio using the Power button.
2. Select the CD mode by repeatedly pressing the MEDIA button or using the radio's Main menu. After selecting the CD mode, the radio's display will show "No disc".
3. Insert a CD with the label side facing up. The radio's

display will show "Reading" and a bar indicating the progress while the CD is being read.

4. After the CD is read, press the PLAY / ►|| button to start / pause playback.
5. Press the V / ◀ button to go to the start of the current track or the previous track when the current track is at the start. If the current track is the first track of a folder on a CD with MP3 or WMA files, the radio will switch back to the last track of the previous folder. Press and hold the V / ◀ button to fast rewind within a track.
6. Press the ►► / ▲ button to go to the next track. If the current track is the last track of a folder on a CD with MP3 or WMA files, the radio will switch to the first track of the next folder. Press and hold the ►► / ▲ button to fast forward within a track.
7. Press the SELECT / ■ button to stop playback. The radio's display will now show the total number of folders and tracks on the CD.

## Showing CD information on the display

When playing audio CDs with MP3 and / or WMA files, repeatedly press the INFO / MENU button to cycle through the following information on the radio's display:

- Progress
- File name
- Album
- Artist
- Title

## 12. Listening to audio from or recording audio to a USB device or SD card

The DDR-66BT is capable of playing MP3 and WMA files (with the exception of files encoded using WMA lossless, WMA Voice, WMA 10 professional and files with DRM protection) from USB devices or SD cards.

**Note:**

**The USB DC output is available only in CD, USB, and SD modes. It is not available in any other mode.**

### Playing files from a USB device or SD card

To play audio files from a USB device or SD card, follow these steps:

1. Turn on the radio using the Power button.
2. Insert the USB device in the USB port or SD card in the SD card slot.
3. Select the USB or SD mode by repeatedly pressing the MEDIA button or using the radio's Main menu. After selecting either of these two modes, the radio's display will show "Reading" and a progress bar to indicate the radio is reading the content of the USB device or SD card.
4. After the content of the USB device or SD card has been read, playback of the first track of the first folder will automatically start. The display will show "F01 T001 00:00". This represents the folder number, track number and play time respectively.
5. Press the PLAY / ►|| button to pause / resume

playback.

6. Press the **V / I◀◀** button to go to the start of the current track or the previous track when the current track is at the start. If the current track is the first track of a folder, the radio will switch back to the last track of the previous folder. Press and hold the **V / I◀◀** button to fast rewind within a track.
7. Press the **▶▶ / ^** button to go to the next track. If the current track is the last track of a folder, the radio will switch to the first track of the next folder. Press and hold the **▶▶ / ^** button to fast forward within a track.
8. Press the **SELECT / ■** button to stop playback. The radio's display will now show the total number of folders and tracks on the USB device or SD card.

## Recording audio to a USB device or SD card

To record audio that is being played by the radio to a USB device or SD card, follow these steps:

1. Turn on the radio using the Power button.
2. Insert the USB device in the USB port or SD card in the SD card slot.
3. Select the desired mode and playback the audio that you want to record.
4. Press the **RECORD** button. The radio will now initialize recording to the USB device or SD card.  
**Note:**  
If both a USB device and SD card have been inserted, the radio will record to the storage device that is selected under **[Rec. default dest.]** in the System settings menu (refer to chapter 14 "Using the System settings menu" for more information about this feature). The top right corner of the radio's display shows the storage device that the recording is saved to.
5. Press the **REC** button again to stop the recording.
6. Recordings are saved as MP3 files named "RECXXX" (XXX being the number of the recording, so the first recording is named "REC001", the second "REC002", etc.) in a folder named "REC" on the storage device.

## Showing track information on the display

When listening to audio from a USB device or SD card, repeatedly press the **INFO / MENU** button to cycle through the following information on the radio's display:

- Filename
- Album
- Artist
- Title

## 13. Listening to audio using the Aux in socket

You can listen to the sound of an external device (such as an iPod or MP3 player) through the speakers of the DDR-66BT. To do this, follow these steps:

1. Connect the external device to the radio's Aux in socket using a 3.5mm audio cable (not included).

2. Make sure both the radio and the external device are turned on.
3. Select the AUX in mode by repeatedly pressing the **RADIO** button or using the radio's Main menu.
4. The audio output of the external device will now be played through the speakers of the DDR-66BT. Playback must be controlled on the external device, while the volume can be controlled both on the radio and on the external device.

## 14. Using the System settings menu

The System settings menu can be used to configure the DDR-66BT. Follow these steps to access the System settings menu:

1. Turn on the radio using the Power button.
2. Press and hold the **INFO / MENU** button to open the menu for the current mode.
3. Use the **V / I◀◀** and **▶▶ / ^** buttons to select **[System settings]** and press the **SELECT / ■** button to open the menu.

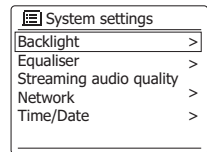

System settings	
Backlight	>
Equaliser	>
Streaming audio quality	>
Network	>
Time/Date	>

The System settings menu offers the following options:

- **[Backlight]:** Select this option to configure the brightness of the radio's backlight. The subsequent option **[Normal]** allows you to set the backlight brightness when the radio is powered on, while **[Standby]** allows you to set the backlight brightness for when the radio is in standby mode.
- **[Equaliser]:** Select this option to configure the radio's equaliser mode. The subsequent option **[My EQ profile setup]** option allows you to manually configure the bass level and treble level for the radio's **[My EQ]** equaliser mode.
- **[Loudness]:** Select this option to enable or disable the radio's loudness feature.
- **[Streaming audio quality]:** Select this option to configure the streaming audio quality.
- **[Network]:** Select this option to configure the radio's network connection, view and select available network profiles, run PBC setup or view the network settings.
- **[Time / Date]:** Select this option to set the time and date manually, to set the source for automatically updating the time and date and set the time format.
- **[Inactive Standby]:** Select this option to configure the time after which the radio automatically switches to the standby mode when not being used.
- **[Language]:** Select this option to configure the language in which the radio's menus are shown.
- **[Rec. default dest.]:** Select this option to configure the default destination for recording files. When both a USB device and SD card are inserted into the radio and recordings are being made, the files will be stored on the storage device that is configured here.
- **[Factory reset]:** Select this option to reset the radio to the default factory settings. After confirmation, all user settings and preset stations will be erased.

- **[Software update]:** Select this option to configure whether the radio should occasionally check for available software updates or to check for available software updates.
- **[Setup wizard]:** Select this option to perform the Setup wizard again, either right away or at the next startup. Refer to chapter 3 "Getting started" for more information on using the Setup wizard.
- **[Info]:** Select this option to view the radio's Spotify version, Radio ID and Friendly Name.
- **[Privacy policy]:** Select this option to display the link to the radio's privacy policy.

## Manually setting the time and date

Setting the radio's date and time works slightly different from configuring most of the other radio's options and features. If you would be unable to automatically update the time and date using the DAB, FM or network, follow these steps to manually set the time and date:

1. Open the System settings menu using the three steps previously described.

2. Select **[Time / Date]**.

The Date / Time submenu offers the following options:

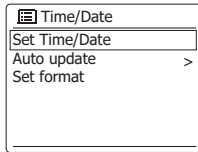

- **[Set Time / Date]:** Select this option to manually configure the time and date.
  - **[Auto update]:** Select this option to select a source for automatically updating the time and date.
  - **[Set format]:** Select this option to select the 12 or 24 hour format.
3. Select **[Set Time / Data]** and press the SELECT / ■ button to manually set the radio's time and date.
  4. The radio's display will show the date and time and the day digits are blinking on the display.
  5. Use the V / I◀◀ and ▶▶I / ^ buttons to select the current day and press the SELECT / ■ button to confirm.
  6. Next, the month digits will blink on the display.
  7. Use the V / I◀◀ and ▶▶I / ^ buttons to select the current month and press the SELECT / ■ button to confirm.
  8. Next, the year digits will blink on the display.
  9. Use the V / I◀◀ and ▶▶I / ^ buttons to select the current year and press the SELECT / ■ button to confirm.
  10. Next, the hour digits will blink on the display.
  11. Use the V / I◀◀ and ▶▶I / ^ buttons to select the current hour and press the SELECT / ■ button to confirm.
  12. Next, the minute digits will blink on the display.
  13. Use the V / I◀◀ and ▶▶I / ^ buttons to select the current minutes and press the SELECT / ■ button to confirm.
  14. Manually setting the time is now completed and the radio will return to the Date / Time submenu.

## 15. Using the Main menu

The Main menu can be used to select the radio's mode or to set the alarms and sleep timer of the radio. Follow these steps to access the Main menu:

1. Turn on the radio using the Power button.
2. Press and hold the INFO / MENU button to open the menu for the current mode.
3. Use the V / I◀◀ and ▶▶I / ^ buttons to select **[Main menu]** and press the SELECT / ■ button to open the menu.

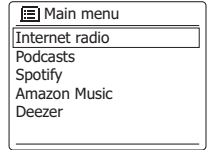

The Main menu offers the following options:

- **[Internet radio]:** Select this option to switch to the Internet radio mode.
- **[Podcasts]:** Select this option to switch to the Podcast mode.
- **[Spotify]:** Select this option to switch to the Spotify mode.
- **[Amazon Music]:** Select this option to switch to the Amazon Music mode.
- **[Deezer]:** Select this option to switch to the Deezer mode.
- **[DAB]:** Select this option to switch to the DAB radio mode.
- **[FM]:** Select this option to switch to the FM radio mode.
- **[CD]:** Select this option to switch to the CD mode.
- **[USB]:** Select this option to switch to the USB mode.
- **[SD]:** Select this option to switch to the SD mode.
- **[Bluetooth]:** Select this option to switch to the Bluetooth mode.
- **[AUX in]:** Select this option to switch to the AUX in mode.
- **[Sleep]:** Select this option to set the radio's sleep timer.
- **[Alarms]:** Select this option to set the radio's alarms.
- **[System settings]:** Select this option to go to the System settings menu (refer to chapter 14 "Using the System settings menu" for more information on this menu).

## Setting the alarms

The radio's alarms can be set by pressing the ALARM button while the radio is powered on or using the [Alarms] option in the Main menu. Follow these steps to set the radio's alarms:

1. Turn on the radio using the Power button.
2. Press the ALARM button or open the Main menu, select [Alarms] and press the SELECT / ■ button.

3. Both alarms and their settings will be shown on the display. Select the alarm that you want to set.

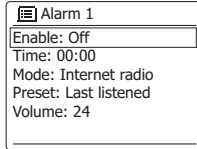

The submenu for configuring an alarm offers the following options:

- **[Enable]:** Select this option to configure the alarm frequency, the available settings here are [Off], [Daily], [Once], [Weekends] and [Weekdays].
  - **[Time]:** Select this option to set the alarm time. This can be done in the same way as setting the time and date in the previous chapter.
  - **[Mode]:** Select this option to set the mode that is used for the alarm.
  - **[Preset]:** Select this option to select a preset or the last listened station as the alarm source.
  - **[Volume]:** Select this option to set the alarm volume.
  - **[Save]:** Select this option to save the alarm settings.
4. Set all the first five of the above options using the V / I◀◀, ▶▶I / ^ and SELECT / ■ buttons.
  5. Select [Save] and press the SELECT / ■ button.
  6. To configure the other alarm, select the other alarm in step 2 and repeat steps 3 and 4.

### Notes:

- When an alarm sounds, press the Power button to turn off the alarm and switch the radio back to the standby mode. Repeatedly press any of the other buttons on the radio (except for the VOLUME + and - buttons) to snooze the alarm for the number of minutes displayed on the radio's display.
- Alarms will stop sounding after 60 minutes have elapsed since the start of the alarm.
- Alarms can be quickly enabled and disabled by repeatedly pressing the ALARM button in the standby mode.

## Setting the sleep timer

The sleep timer allows you to automatically turn off the radio after a preset time has elapsed. It can be set from 15 to 120 minutes using by pressing and holding the Power / Sleep button on the radio and then using the V / I◀◀ or ▶▶I / ^ button to select the desired sleep time or by using the [Sleep] option from the Main menu.

Follow the steps below to set the sleep timer using the radio's Main menu:

1. Open the Main menu using the three steps previously described.
2. Select [Sleep] and press the SELECT / ■ button.

3. Press the V / I◀◀ or ▶▶I / ^ button to select the desired sleep time.
4. After the sleep time has elapsed, the radio will automatically switch to the standby mode. An active sleep timer is shown using a small sleep timer icon at the bottom of the playback displays. This icon also shows the sleep time remaining before the radio switches to the standby mode.
5. To cancel the sleep time before the preset time has elapsed and to turn off the radio, press the Power button to turn the unit off manually. To cancel the sleep timer and leave the radio playing, go back into the sleep timer settings (steps 1 to 3 above) and select the "Sleep OFF" option in step 3.

## Product specifications

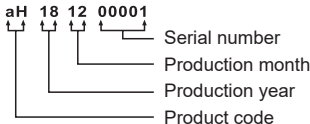
Power Requirements	
Mains Power supply	AC 100-240 V, 50/60 Hz / 32W
Remote Control Battery	2 x AAA
Frequency Coverage	
FM	87.5-108 MHz
DAB	174.928-239.200 MHz
Wired Ethernet	10 / 100M bits / sec via RJ-45 socket
Wi-Fi	802.11 b, g, n, a supported with WEP and WPA / WPA2 encryption. Compatible with 2.4GHz and 5GHz WiFi bands. The frequency and maximum transmitted power: WiFi: 2412MHz ~ 2472MHz, EIRP=13dBm 5180MHz ~ 5240MHz & 5745MHz ~ 5825MHz, EIRP=8dBm Operations in the 5.15-5.35GHz band are restricted to indoor usage only.
Bluetooth	
Bluetooth version	5.0
Supported Bluetooth profiles	A2DP, AVRCP
Supported Bluetooth codecs	SBC and AAC
Bluetooth range	approx. 10m (30 feet)
Bluetooth Frequency and maximum transmitted power	2402MHz ~ 2480MHz: 0dBm (Bluetooth EDR)
Circuit features	
Loudspeaker	2 x 3"
Output power	12 Watts x 2 (peak)
	7 Watts x 2 (continuous)
Headphone socket	3.5mm diameter, stereo
Aux In socket	3.5mm diameter, stereo
Line Out socket	3.5mm diameter, stereo
Aerial System	Wi-Fi antenna
	DAB Telescopic aerial
	FM Telescopic aerial
Operating temperature range	0°C to + 35°C
Information on Power Consumption	
Power standby	The device has a standby mode with a power consumption of less than 0.8W.
Bluetooth mode	In Bluetooth mode, when there is no signal output, the idle power consumption is 2.0W after 15 minutes.
AUX mode	In AUX mode, when there is no signal output, the idle power consumption is 0.8W after 15 minutes.
※ The barcode label on the product is defined as below:	
	 <p>Serial number</p> <p>Production month</p> <p>Production year</p> <p>Product code</p>

Sangean reserves the right to amend the specifications without notice.

 RECYCLING This product bears the selective sorting symbol for Waste electrical and electronic equipment (WEEE). This means that this product must be handled pursuant to European directive 2012/19/EU in order to be recycled or dismantled to minimize its impact on the environment.