

WFR-28BT

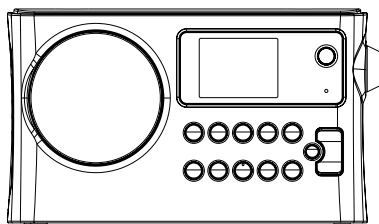

GB

Version 4

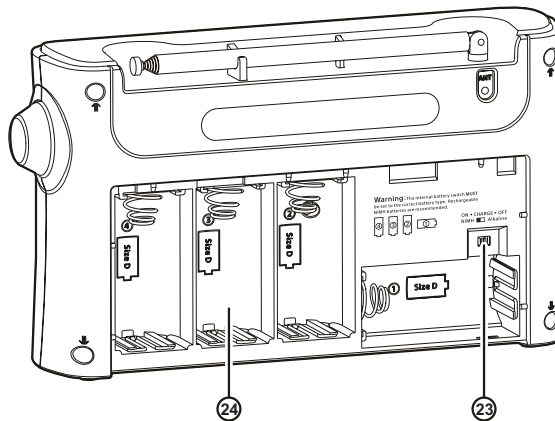
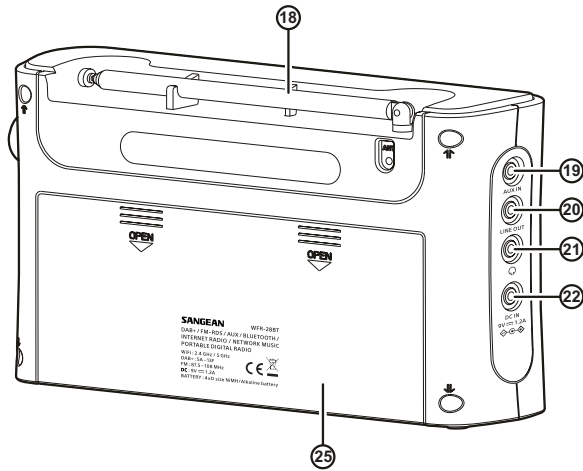
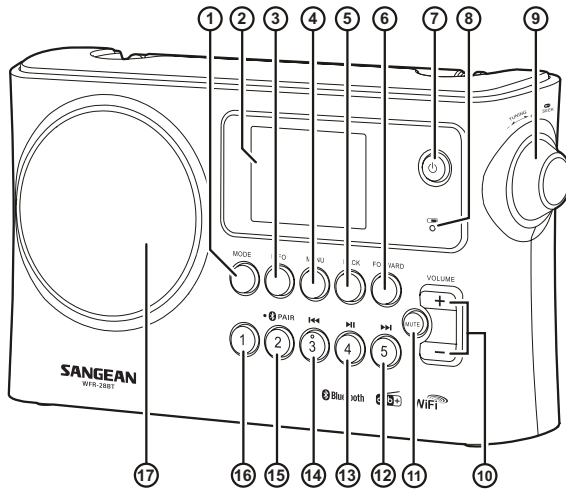



The Bluetooth® word mark and logos are registered trademarks owned by Bluetooth SIG, Inc. and any use of such marks by SANGEAN ELECTRONICS, INC. is under license.

Contents

1. IMPORTANT SAFETY INSTRUCTIONS	04-05
2. Introduction	05-06
Overview of the main unit	05-06
3. Getting started	06-08
Finding a suitable location for the radio	06
Powering the radio	06
Battery operation	06
AC operation	06
Charging the batteries.....	07
Performing the radio's initial setup	07-08
Turning the radio on / off	08
Selecting a playback source	08
Using the radio's Main menu.....	08
Using the Mode button	08
4. Controlling the radio using the UNDOK app	08-09
Using the UNDOK app to control the radio	08-09
Configuring the radio's settings using the UNDOK app	09
5. Listening to Internet radio	09-11
The Internet radio menu	09-10
Storing Internet radio stations as presets	10
Recalling Internet radio station presets.....	10
Customizing your preset list using a web browser	10-11
Showing Internet radio information on the display	11
6. Listening to Podcasts	11-12
The Podcast menu	12
Showing Podcast information on the display ..	12
7. Listening to Spotify	12
8. Listening to DAB radio	12-13
Tuning into DAB stations	12
The DAB radio menu.....	12-13
Showing DAB information on the display	13
Storing preset stations in the DAB radio mode.....	13
Recalling a preset station in the DAB radio mode.....	13
9. Listening to FM radio	13-14
Tuning into FM stations	13
The FM radio menu	13
Showing FM information on the display	13
Storing and recalling preset stations in the FM radio mode.....	14
10. Listening to Bluetooth audio	14-15
Pairing your Bluetooth device for the first time	14
Audio playback in the Bluetooth mode	14
Audio playback from a previously-paired Bluetooth device	14
The Bluetooth menu	15
Disconnecting your Bluetooth device.....	15
Showing Bluetooth information on the display.....	15
11. The Aux in, Line out and headphones sockets	15
Listening to audio from an external device using the Aux in socket	15
Output audio to an external device using the Line out socket	15
Connecting a pair of headphones to the radio	15
12. Using the System settings menu	15-16
Manually setting the time and date	16
13. Using the Main menu	16-17
Setting the alarms	17
Setting the sleep timer	17
14. Specifications	18

GB

1. IMPORTANT SAFETY INSTRUCTIONS

1. Read and understand all safety and operating instructions before the radio is operated.
2. Retain instruction: The safety and operating instructions should be retained for further reference.
3. Heed warnings. All warnings on the appliance and operating instructions should be followed.
4. Follow all operations and use instructions.
5. Water and moisture: The appliance should not be used near water. Do not use near a bathtub, washbowl, laundry tub, kitchen sink, wet basement, swimming pool, etc.
6. Unplug the radio from the AC power outlet before cleaning. Use only a damp cloth for cleaning the exterior of the radio.
7. Do not place the radio on an unstable cart, stand, bracket or table. The radio may fall, causing serious personal injury and damage to the radio.
8. Ventilation: This radio should be situated so that its location or position does not interfere with its proper ventilation. For example, the radio should not be used on a bed, sofa, rug or other soft surfaces that may block the ventilation openings. It should not be placed in a built-in situation like a cabinet that may reduce air flow through the ventilation openings.
9. Power sources: The radio should be operated only from the type of power source indicated on the marking label. If you are not sure of the type of power supply to your home, consult your radio dealer or power company.
10. Mains adaptor: The mains adaptor should be positioned so it is not walked on, pinched, or items placed on top of it. Pay particular attention to wires at plugs, convenience receptacles, and the point where they exit from the unit. Unplug the mains adaptor by gripping the adaptor, not the wire. Operate the radio using only the current type of power source indicated. If you are not sure of the type of power supply to your home, consult your dealer or local power company.
11. Do not overload wall outlets or extension cords. This can result in a risk of fire or electrical shock. Never insert objects of any kind into the radio through opening.

The objects may touch dangerous voltage points or short out parts. This could cause a fire or electrical shock.
12. If the radio is left unattended or unused for long periods of time, unplug it from the wall outlet. This will prevent damage caused by unplug it from the wall outlet. This will prevent damage caused by lightning or power line surges.
13. If the radio is left unattended and used for a long period of time, remove the batteries. The batteries may leak and damage furniture or your radio.
14. Do not attempt to service the receiver yourself. Removing the cover may expose you to dangerous voltage, and will void the warranty. Refer all servicing to authorized service personnel.
15. Never push objects of any kind into this radio through opening as they may touch dangerous voltage points

or short-out parts that could result in a fire or electric shock. Never spill liquid of any kind into the product.

16. The appliance should be serviced by qualified service personnel when:
 - The power supply cord or the plug has been damaged.
 - Objects have fallen or liquid had been spilled into the radio.
 - The radio has been exposed to rain or water.
 - The radio does not appear to operate normally or exhibits a marked change in performance.
 - The radio has been dropped, or the enclosure damaged.
17. To prevent possible hearing damage, do not listen at high volume levels for long periods.









18. ⚠ CAUTION:

- minimum distances around the apparatus for sufficient ventilation;
 - the ventilation should not be impeded by covering the ventilation openings with items, such as newspaper, table-cloths, curtains, etc.;
 - no naked flame sources, such as lighted candles, should be placed on the apparatus;
 - attention should be drawn to the environmental aspects of battery disposal;
 - the use of apparatus in tropical and / or moderate climates.
19. A warning that batteries (battery pack or batteries installed) shall not be exposed to excessive heat such as sunshine, fire or the like.
 20. The mains plug of power adapter is used as the disconnect device. The power outlet must be installed near the equipment and must be easily accessible.

Important information on charging and using rechargeable batteries

1. Recharge the batteries in any case at least every 2 months.
2. Make sure the Battery Select switch inside the battery compartment is set to the "NiMH" position.
3. Put the batteries in the compartment while paying attention to the correct polarity of the batteries (+ and -).
4. First use: Charge new batteries in one continuous, uninterrupted, charge until they are full. This first charge may take longer than normal. For longer battery life it is advised to always recharge in one continuous, uninterrupted charge until batteries are full and to not recharge again while the batteries are still full.
5. New batteries will only reach their full capacity after some time of use (several charge and discharge cycles).
6. Leave the complete group of batteries in place inside the radio and do not use these batteries or a few of them for other purposes. This will result in a mix of (fully) charged and (partly) empty batteries. This can seriously damage the batteries and radio when recharged.

7. It is advised to only charge batteries at room temperatures between 5 degrees C – 35 degrees C. In lower or higher temperatures full charge cannot be achieved.
8. Depending on the capacity of the batteries, charging from “empty” to “full” can take several hours, even up to 6 hours or more.
9. Do not charge batteries when the radio is hot or exposed to heat or heat sources.
10. It is advised to clean the metal contacts of the batteries and of the charger inside the radio e.g. with a contact-spray from time to time.
11. Do not use a mix of old and new rechargeable batteries.
12. Do not use a mix of rechargeable and non-rechargeable batteries.
13. Do not use a mix of full and empty rechargeable batteries.
14. Do not use batteries that have a different mAh capacity.
15. Do not use damaged, deformed or leaking batteries.
16. Battery level indication is an approximate indication only and can vary with battery type that is used.
17. Batteries can become hot during charging.
18. In cold conditions the capacity of batteries will be much lower than when used at normal room temperature.
19. Batteries (even when supplied with the radio), as being consumables, do not fall under the warranty conditions of the radio.
20. Batteries should not be disposed of by incineration and with household waste.
21. Disposable batteries should be taken to a suitable recycling center if possible.
22. **⚠ CAUTION:** “Risk of explosion if the battery is replaced by an incorrect type.”
23. **Warning:** Avoid replacing the battery with an incorrect type.
24. Don't dispose of batteries into fire or a hot oven, or mechanically crushing or cutting batteries.
25. Don't leave batteries in an extremely high temperature environment.
26. Avoid subjecting batteries to extremely low air pressure.

	The symbol indicates energy efficiency marking.
	The symbol indicates polarity of DC power connector.
	The symbol indicates AC voltage.
	The symbol indicates DC voltage.
	The symbol indicates class II equipment.
	For indoor use only.

2. Introduction

Overview of the main unit

- ① Mode button
 - Press repeatedly to select the desired mode.
- ② LCD display
- ③ Info button
 - Press to cycle through information from the playback source on the radio's display.
- ④ Menu button
 - Press to open the menu for the current mode.
 - While in the radio's menu, press to go back to the main menu for the current mode or to close the menu when the display is already showing the current mode's main menu.
- ⑤ Back button
 - While in the radio's menu, press to go back one step.
- ⑥ Forward button
 - While in the radio's menu, press to go forward one step or to confirm the selected item.
 - Press this button to scan for radio stations in the FM radio mode.
- ⑦ Power button
 - Press to switch the radio on / off.
- ⑧ Battery indicator
- ⑨ Tuning / Select / Seek knob
 - While in FM radio mode, rotate to increase / decrease the frequency.
 - While in FM radio mode, rotate and then press to automatically scan for stations with a lower / higher frequency.
 - While in the radio's menus, rotate to select items in and then press to confirm your choice.
- ⑩ Volume + / - button
 - Press to increase / decrease the radio's volume.
- ⑪ Mute button
 - Press to enable / disable the radio's mute feature.
- ⑫ Preset 5 / Next / Fast Forward button
 - Press to select Preset station 5 in the DAB radio, FM radio, or Internet radio mode.
 - Press and hold to save the currently tuned station to Preset 5 in the DAB radio, FM radio, or Internet radio mode.
 - Press to go to next track in the Bluetooth or Podcast mode.
 - Press and hold to fast forward in the Bluetooth or Podcast mode.
- ⑬ Preset 4 / Play / Pause button
 - Press to select Preset station 4 in the DAB radio, FM radio, or Internet radio mode.

- Press and hold to save the currently tuned station to Preset 4 in the DAB radio, FM radio, or Internet radio mode.
- Press to play / pause the current track in the Music player, Bluetooth, or Podcast mode.

14 Preset 3 / Previous / Rewind button

- Press to select Preset station 3 in the DAB radio, FM radio, or Internet radio mode.
- Press and hold to save the currently tuned station to Preset 3 in the DAB radio, FM radio, or Internet radio mode.
- Press to go to the start of the track or the previous track in the Bluetooth, or Podcast mode.
- Press and hold to rewind in the Bluetooth, or Podcast mode.

15 Preset 2 / Bluetooth pairing button

- Press to select Preset station 2 in the DAB radio, FM radio, or Internet radio mode.
- Press and hold to save the currently tuned station to Preset 2 in the DAB radio, FM radio, or Internet radio mode.
- While in Bluetooth mode, press and hold to switch to the Bluetooth pairing mode.

16 Preset 1 button

- Press to select Preset station 1 in the DAB radio, FM radio, or Internet radio mode.
- Press and hold to save the currently tuned station to Preset 1 in the DAB radio, FM radio, or Internet radio mode.

17 Speaker

18 DAB / FM antenna

- Position and stretch out this antenna correctly to improve the radio's DAB / FM reception.

19 Aux in socket

- 3.5mm socket for audio input from external device.

20 Line out socket

- 3.5mm socket for audio output to external device.

21 Headphones socket

- 3.5mm socket for connecting a pair of headphones.

22 DC IN socket

- Connect the radio's adapter to this port to power the radio using the mains.

23 Battery switch (NiMH / Alkaline)

- Use this switch to configure what type of batteries you are using, NiMH (rechargeable) or Alkaline (non-rechargeable).

24 Battery compartment

- Battery operation requires 4 x D size (AM-1) batteries.

25 Battery compartment cover

- Remove this cover by sliding it down when placing batteries or placing the battery switch in the correct position. Place it back afterwards by sliding it back up into the slots.

3. Getting started

Follow the instructions in this chapter to get your WFR-28BT up and running in no time.

Finding a suitable location for the radio

After unpacking the radio from the box, take the following guidelines into account when finding a suitable location for the radio:

- Place the radio on a flat, even surface such as a table.
- Do not place the radio near heat sources.
- Make sure there is sufficient space available around the radio for proper ventilation.
- If you are planning to connect the radio to your Wi-Fi network, make sure to place the radio in a location where Wi-Fi reception is good.
- Avoid placing the radio near appliances that can interfere with Wi-Fi reception, such as microwaves.

Powering the radio

The WFR-28BT can be powered using the power adapter or by using 4 x D size (AM-1) Alkaline or NiMH batteries.

Battery operation

To power the radio using battery power, follow these steps:

1. Open the battery compartment cover on the back of the radio by pushing it down in the direction of the arrows.
2. Before inserting the batteries, make sure the battery switch inside the battery compartment is placed in the correct position (Alkaline or NiMH, corresponding to your batteries).
3. Insert 4 x size D (AM-1) batteries into the battery compartment with polarities as shown in the diagram inside the battery compartment.
4. Close the battery compartment by pushing the cover back into place.

Note:

Reduced power, distortion and a "stuttering sound" or a red battery indicator are all signs that the batteries need to be replaced or recharged. Instructions on recharging the batteries can be found below.

AC operation

Before connecting the WFR-28BT's power adapter (included) to the wall socket, please ensure that the voltage that the wall socket supplies is within the supported range printed at the power adapter (100-240 V ~ 50/60 Hz). If this is the case, first connect the connector of the power adapter to the radio and then insert the plug of the power adapter into the wall socket.

Charging the batteries

Before charging batteries, make sure the battery switch inside the battery compartment is placed in the NiMH position and that rechargeable NiMH batteries are being used. After inserting the batteries into the battery compartment, simply connect the radio to a wall socket to charge the batteries. The battery indicator will blink green while the batteries are being charged and will continuously be lit green when the batteries are fully charged. If the radio is in the Standby mode, it will show icons for all batteries and charging progress is displayed. Fully charging a set of batteries will take approximately 6 hours. This time may vary, however, depending on the capacity of the batteries.

Notes:

- **The first principle of charging is safety, so batteries with different capacities have different safety regulations.**

The device can fully charge and discharge the capacity of the battery below 7000mAh.

When using a battery of more than 7000mAh, it is recommended to complete the first charge before performing the second charge. It is not fully charged at one time, it needs to be unplugged and plugged in again for a second charge.

- **The maximum charging time may vary slightly with an error range of 1 hour.**

The battery indicator will light red when the radio's batteries are low and the radio's display will show the message "Low Battery". In this case the batteries need to be charged or replaced soon. If an error occurs while the batteries are being charged, the radio's battery indicator will blink red. Furthermore, in the Standby mode the radio's display will show a white battery icon with a red "X" to indicate which battery is causing the issue. Replace this battery to solve the issue and then reconnect the radio's power adapter to ensure the batteries are being charged.

Performing the radio's initial setup

After your WFR-28BT has been supplied with power for the first time, it will automatically turn on. While the radio is starting up, "SANGEAN" will be shown on the radio's display. When the software is loaded the radio's Setup Wizard will automatically be started.

The radio's Setup Wizard will guide you through the configuration of the radio's time format, method for updating the time and date and network connection.

1. When the Setup Wizard is displayed, it will ask first if you want to start the Setup Wizard now. Use the Tuning knob to select **[Yes]** or **[No]** and press Tuning knob to confirm your choice. Select **[Yes]** to proceed with the Setup Wizard or select **[No]** to directly go to the radio's Main menu without configuring the radio's time format, method for updating the time and date and network connection.
2. After selecting **[Yes]**, the radio's display will show "12 / 24 hour format". Use the Tuning knob to select the desired hour format and then press the Tuning knob to confirm your choice.

3. Next, the auto update list is shown on the radio's display.

Auto update
Update form DAB
Update form FM
Update form Network *
No update

Use the Tuning knob to select one of the 4 following options:

- **[Update from DAB]:** Synchronize the radio's time and date using DAB stations.
 - **[Update from FM]:** Synchronize the radio's time and date using FM stations.
 - **[Update from Network]:** Synchronize the radio's time and date using a network connection.
 - **[No update]:** Time and date will not be synchronized and has to be set manually.
4. If **[Update from Network]** was selected in the previous step, the radio will ask you to set the timezone. Rotate the Tuning knob to select the timezone for your region and press the Tuning knob to confirm.
 5. When updating the time from the network, the radio will also ask you to either enable or disable Daylight savings. Use the Tuning knob to select and confirm either **[Yes]** or **[No]** and to enable or disable Daylight Savings Time (DST) respectively.
 6. Next, the radio will ask if you want to keep the radio connected to the network. Use the Tuning knob to select **[Yes]** or **[No]** and press the Tuning knob to confirm your choice. If **[No]** is selected here, when a mode is used that does not require an internet connection or when the radio is in the Standby mode, the radio will automatically disconnect from the network after a short period of time and automatically reconnect to the network when internet is needed.
 7. The Network Wizard will now scan for networks and show a list of Wi-Fi networks that are detected by the radio along with an option to scan again and an option to manually configure the network connection.

SSID
youmib1919
youmib1920
youmib1921
[Rescan]
[Manual config]

Use the Tuning knob to select one of the options:

- **[Name of a Wi-Fi network]:** Select the name of a Wi-Fi network to proceed to the password entry screen for the selected network.
 - **[Rescan]:** Select this option to scan for Wi-Fi networks again.
 - **[Manual config]:** Select this option to manually configure the radio's internet connection (DHCP enabled / disabled, SSID, authentication method, encryption type and password).
8. If you have connected to a Wi-Fi network, an icon indicating the network's signal strength will appear in the bottom bar of the radio's display.
 9. You have now completed the Setup Wizard and are ready to start using your WFR-28BT. After completing the Setup Wizard, the radio's Main menu will be shown on the display.

Notes:

- All of the radio's menus can be navigated by rotating the Tuning knob to select an option and then pressing the Tuning knob to open or confirm the selection.
- In many cases the Forward and Back buttons can also be used to navigate the radio's menus and to select items. In the instructions in this manual we will be used the Tuning knob, however, as in some cases the Forward and Back buttons have different functionality.
- During the Setup Wizard, the radio's default and recommended settings are indicated using an asterisk.
- In order to use any of the radio's internet features or to control the radio using the UNDOK app, the radio must be connected to a network that has internet access.

GB

Turning the radio on / off

The WFR-28BT can be switched on or off by pressing the Power button. After the radio is turned on, it will automatically select the last used source. When the radio is turned off, it will switch over to the Standby mode when connected to mains power or completely switch off when using battery power.

Selecting a playback source

There are two ways to select a playback source:

Using the radio's Main menu

Open the radio's Main menu by pressing the Menu button, select **[Main menu]** by rotating the Tuning knob and open the Main menu by pressing the Tuning knob. Next, select the playback source by rotating the Tuning knob and press the Tuning knob to confirm your choice (refer to chapter 13 "Using the Main menu" for details regarding the radio's Main menu).

Using the Mode button

Repeatedly press the Mode button to select the desired mode.

4. Controlling the radio using the UNDOK app

Aside from controlling your WFR-28BT with the buttons on the radio, it can also be controlled from a smart device using the UNDOK app. The UNDOK app offers an intuitive and easy to use user interface, allows you to configure many of the radio's settings and is available for Android and iOS.



UNDOK

Using the UNDOK app to control the radio

Follow these steps to use the UNDOK app to control the radio:

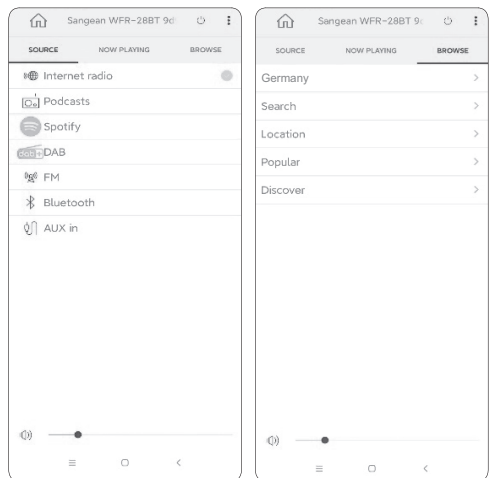
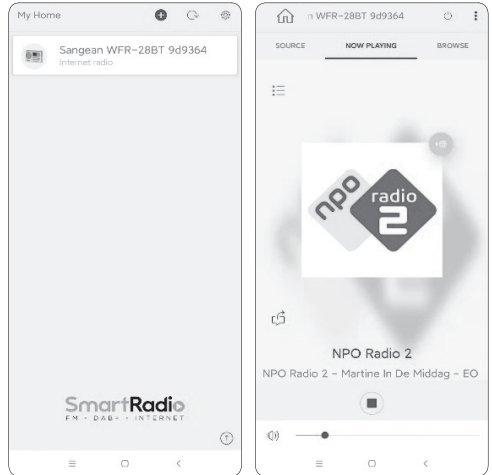

1. Download and install the UNDOK app for your device by searching for "UNDOK" in Apple's App Store or the Google Play Store.
2. Make sure the radio and your smart device are connected to the same network. Instructions for connecting the radio to your network can be found in the "Performing the radio's initial setup" section of chapter 3 "Getting started".
3. Open the UNDOK app on your smart device.

After starting the UNDOK app, your WFR-28BT should appear on the home screen of the app with the name "Sangean WFR-28BT xxxxxx" (the 6 digit alphanumeric code are the last 6 digits of your radio's MAC address).

4. Connect to the radio by tapping on it.

5. Select the "Source" tab in the upper left corner to select the radio's playback source.
6. Select the "Browse" tab in the upper right corner to browse through content for the selected source.
7. Playback, tuning and volume can be controlled using the controls in the app.

Note:

These instructions and screenshots are based on the Android version of the UNDOK app for smartphones. If you are using a different type of device, the screen layout and / or icons may be slightly different.

Configuring the radio's settings using the UNDOK app

Follow these steps to configure the radio's settings using the UNDOK app:

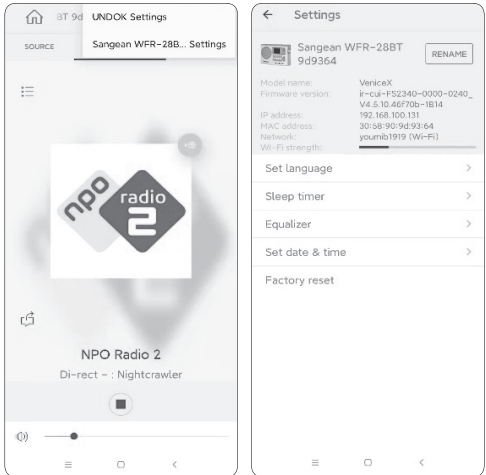

1. Start the UNDOK app on your smart device and connect to the radio as previously described.
2. Tap the three dots icon in the upper right corner of the screen and select "Sangean WFR-28BT xxxxxx Settings".
3. The radio's settings that can be configured using the UNDOK app now appear on the smart device's screen. To configure any setting, simply tap it and set it to the desired value.

Note:

These instructions and screenshots are based on the Android version of the UNDOK app for smartphones. If you are using a different type of device, the screen layout and / or icons may be slightly different.

5. Listening to Internet radio

The WFR-28BT is capable of receiving tens of thousands of internet stations from around the world when the radio is connected to the internet via Wi-Fi.

To listen to Internet radio, follow these steps:

1. Turn on the radio using the Power button.
2. Select the Internet radio mode by repeatedly pressing the Mode button or using the radio's Main menu.
3. If the Internet radio mode is being used for the first time, the Internet station selection menu is displayed on the radio's display.

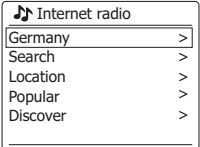

Select one of the options to tune into an Internet radio station:

- **[Your country]:** Select this option to tune into Internet radio stations from your country ("Germany" in the image above). After selecting this option, you can choose to tune into local Internet radio stations or popular radio stations from your country, or to search for Internet radio stations from your country based on a genre or a city.
 - **[Search]:** Select this option to search for an Internet radio station by name. After selecting this option, use the Tuning knob to input the search keyword.
 - **[Location]:** Select this option to find and tune into Internet radio stations by location. Locations from all around the world can be selected in this submenu.
 - **[Popular]:** Select this option to tune into popular Internet radio stations from around the world.
 - **[Discover]:** Select this option to filter Internet radio stations by origin, genre and language.
4. After selecting a radio station using one of the options described above, the radio will tune into and start playing the selected station.

The Internet radio menu

You can open the Internet radio menu by pressing the Menu button while the radio is in the Internet radio mode.

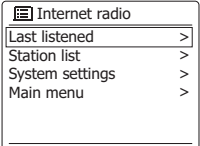

The Internet radio menu offers the following options:

- **[Last listened]:** Select this option to view a list of the last Internet radio stations and Podcasts you've tuned into previously.
- **[Station list]:** Select this option to go to the internet station selection menu described in the previous section.
- **[System settings]:** Select this option to go to the System settings menu and configure the radio (refer to chapter 12 "Using the System settings menu" for details).
- **[Main menu]:** Select this option to go back to the Main menu, where you can switch to any of the radio's modes or set the radio's alarms or sleep timer, or go to

the System settings menu (refer to chapter 13 "Using the Main menu" for details).

3. After clicking **[Properties]**, copy the radio's IP address (for example, 192.168.100.131 in the image below).

Storing Internet radio stations as presets

Your WFR-28BT can store up to 5 Internet radio stations or Podcasts as presets. Presets can be recalled quickly without having to go through the radio's menus.

Follow these steps to store an Internet radio station as a preset station:

1. Turn on the radio, select the Internet radio mode and tune into an Internet radio station as previously described.
2. Press and hold one of the Preset buttons (1-5).
3. After storing a preset station, radio's display will show the message "Preset stored" to indicate the preset has been successfully stored under the chosen preset number.
4. Repeat this procedure as needed.

GB

Recalling Internet radio station presets

Simply press one of the radio's Preset buttons (1-5) in the Internet radio mode to recall the corresponding preset.

Customizing your preset list using a web browser

The preset list can also be customized from an external device with an internet browser (such as a PC or a smartphone). Follow these steps to customize your preset list from a Windows PC:

1. Make sure the PC and the radio are connected to the same Wi-Fi network.
2. On the Windows PC, open **[Explorer]**, click on **[Network]** and then right click the WFR-28BT and select **[Properties]**, as shown in the image below.

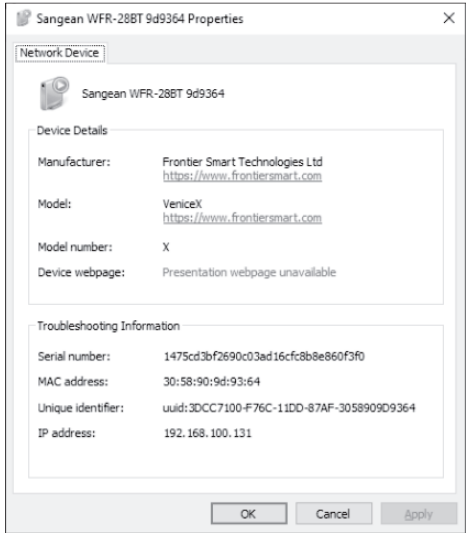

4. Open your internet browser, enter the IP address you have copied as the URL. The following screen will be displayed:

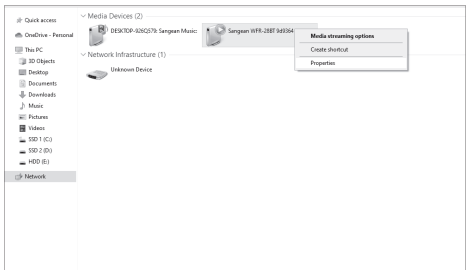
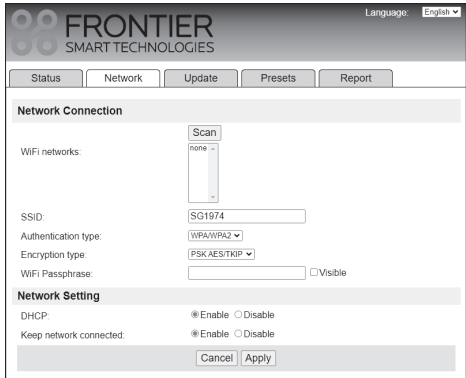

5. Click on the **[Presets]** tab, a screen with the radio's presets will now be displayed:

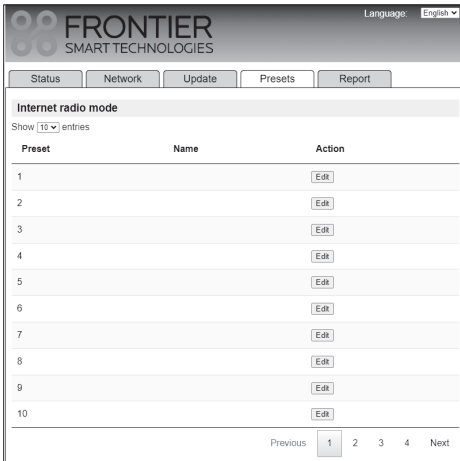

6. If you know the URL of an internet station, you can directly edit the station list on this page by pressing the **[Edit]** button for any of the presets. The following screen is displayed:

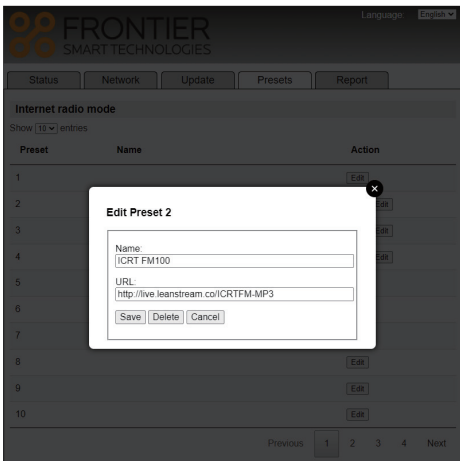

7. After entering the name and the URL of the internet radio station, press the **[Save]** button to save the internet station to the preset list. The radio will then return to the **[Presets]** tab and show the updated station list.

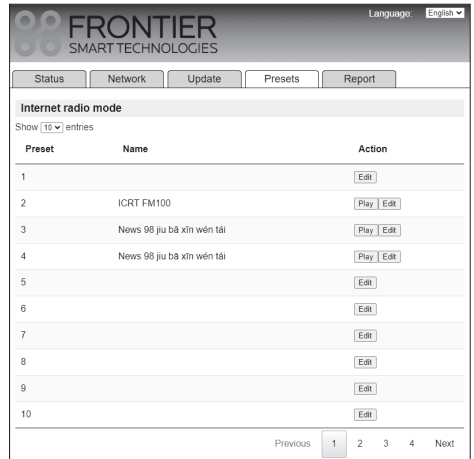

8. To delete a preset, click that preset's **[Edit]** button and then select **[Delete]** on the next screen.

Showing Internet radio information on the display

When listening to an Internet radio station, repeatedly press the Info button to cycle through the following information on the radio's display:

- Artist & track name
- Slogan & Description of station
- Language & Location
- Bit rate, Codec & Sampling rate
- Playback buffer
- Today's date

6. Listening to Podcasts

The WFR-28BT is also capable of tuning into many different Podcasts from around the world.

To listen to Podcasts, follow these steps:

1. Turn on the radio using the Power button.
2. Select the Podcast mode by repeatedly pressing the Mode button or using the radio's Main menu.
3. If the Podcast mode is being used for the first time, the Podcast selection menu is displayed on the radio's display.

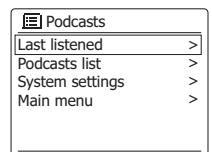

GB

Select one of the options to tune into a Podcast:

- **[Your country]:** Select this option to tune into Podcasts from your country. After selecting this option, you can choose to tune into local Podcasts, popular Podcasts or search for Podcasts from your country by genre.
 - **[Search]:** Select this option to search for a Podcast by name. After selecting this option, use the Tuning knob to input the search keyword.
 - **[Location]:** Select this option to find and tune into Podcasts by location. Locations from all around the world can be selected in this submenu.
 - **[Discover]:** Select this option to filter Podcasts by origin, genre and language.
4. After selecting a Podcast using one of the options described above, the radio will tune into and start playing the selected Podcast.
5. When listening to a Podcast:
- Press the Play / Pause button to pause / resume playback.
 - Press the Next or Previous button to go to the next or previous episode of the current Podcast.
 - Press and hold the Next or Previous button to fast forward or rewind within a Podcast and release the button when the desired point is reached.

GB

The Podcast menu

The Podcast menu is identical to the Internet radio menu described previously, but instead of the option **[Station list]** it has the option **[Podcast list]**, which takes you back to the Podcast selection menu.

Showing Podcast information on the display

When listening to a Podcast, repeatedly press the Info button to cycle through the following information on the radio's display:

- Track progress bar
- Track name
- Track description
- Artist
- Album
- Bit rate, Codec & Sampling rate
- Playback buffer
- Today's date

7. Listening to Spotify

The Spotify Software is subject to third party licenses found here:



<https://www.spotify.com/connect/third-party-licenses>

Use your phone, tablet or computer as a remote control for Spotify. Go to [spotify.com/connect](https://www.spotify.com/connect) to learn how.

8. Listening to DAB radio

Tuning into DAB stations

To tune into DAB radio stations, follow these steps:

1. Turn on the radio using the Power button.
2. Select the DAB radio mode by repeatedly pressing the Mode button or using the radio's Main menu.
3. If this is the first time the DAB radio mode is being used, the radio will automatically perform a full scan in order to find all available DAB radio stations. During the scanning process, as new stations are detected the station counter will increase and the stations will be added to the list which is stored in the radio. The bar graph indicates the progress of the scan.
4. When scanning is completed, the radio will list all stations that were found. Use Tuning knob to scroll through the list of stations and press the Tuning knob to tune into a station.

Note:

Before selecting the DAB radio mode and performing a scan, make sure the DAB / FM antenna at the back of the radio has been fully stretched out and positioned upright.

The DAB radio menu

You can open the DAB radio menu by pressing the Menu button while the radio is in the DAB radio mode.

DAB	
Station list	>
Scan	
Manual tune	>
Prune invalid	
DRC	>

The DAB radio menu offers the following options:

- **[Station list]:** Select this option display all DAB radio stations that were found and tune into one of the stations.
- **[Scan]:** Select this option to perform a full scan and store all DAB radio stations that were found in the station list.
- **[Manual tune]:** Select this option to manually tune into a DAB channel / frequency.
- **[Prune invalid]:** Select this option to delete all unavailable stations from the station list.
- **[DRC]:** Dynamic Range Control (also known as DRC) can make quieter sounds easier to hear when your radio is used in a noisy environment by reducing the dynamic range of the audio signal.

After selecting this option, select the required DRC setting:

[DRC high]: DRC is set as sent by broadcaster.

[DRC low]: DRC level is set to 1 / 2 that sent by broadcaster.

[DRC off]: DRC is switched off. Broadcast DRC will be ignored. This is the default setting.

- **[Station order]:** Select this option and subsequently select **[Alphanumeric]** to sort the station list

alphanumerically or select **[Ensemble]** to sort the station list by DAB multiplex.

- **[System settings]:** Select this option to go to the System settings menu and configure the radio (refer to chapter 12 "Using the System settings menu" for details).
- **[Main menu]:** Select this option to go back to the Main menu, where you can switch to any of the radio's modes or set the radio's alarms or sleep timer, or go to the System settings menu (refer to chapter 13 "Using the Main menu" for details).

Showing DAB information on the display

When listening to a DAB radio broadcast, repeatedly press the Info button to cycle through the following information on the radio's display:

- Text
- Program type
- Multiplex name & Frequency
- Signal error & Strength
- Bit rate, Codec & Audio type
- Today's date

Storing preset stations in the DAB radio mode

The WFR-28BT features 5 memory presets for DAB radio.

1. Turn on the radio, select the DAB mode and then tune to the required radio station as previously described.
2. Press and hold one of the radio's Preset buttons (1-5) to store the station under the corresponding Preset number.
3. Repeat this procedure as needed for the remaining presets.

Recalling a preset station in the DAB radio mode

To recall preset stations in the DAB radio mode, simply turn on the radio, select the DAB radio mode using the Mode button or the radio's Main menu and then press one of the radio's Preset buttons (1-5) to recall the corresponding preset station.

9. Listening to FM radio

Tuning into FM stations

To tune into FM radio stations, follow these steps:

1. Turn on the radio using the Power button.
2. Select the FM radio mode by repeatedly pressing the Mode button or using the radio's Main menu.
3. Rotate the Tuning knob clockwise or anti-clockwise and then press the Tuning knob or the Forward button to automatically tune into an FM station with a higher or lower frequency respectively. Your radio will stop

scanning when it finds a station of sufficient strength. The display will show the frequency of the signal which has been found and a signal strength icon will be shown in the bottom bar of the radio's display to indicate the strength of the signal received. If RDS information is available, an RDS icon will also be shown in the bottom bar of the radio's display and after a few seconds the display will show the radio station name.

4. Rotate the Tuning knob to fine-tune the frequency with steps of 0.05MHz if needed.
5. Repeat the steps 3 and 4 to tune into other radio stations.

Note:

Before selecting the FM radio mode and tuning into stations, make sure the DAB / FM antenna at the back of the radio has been fully stretched out and positioned upright.

The FM radio menu

You can open the FM radio menu by pressing the Menu button while the radio is in the FM radio mode.

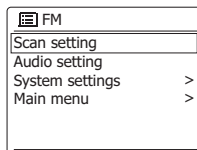

The FM radio menu offers the following options:

- **[Scan setting]:** Select this option to configure if the radio should only look for strong signals or all signals when using the automatic tuning feature (by pressing the Tuning knob).
- **[Audio setting]:** Select this option to enable / disable the force mono playback feature. Forcing the radio to play in mono can improve playback quality when receiving weak signals.
- **[System settings]:** Select this option to go to the System settings menu and configure the radio (refer to chapter 12 "Using the System settings menu" for details).
- **[Main menu]:** Select this option to go back to the Main menu, where you can switch to any of the radio's modes or set the radio's alarms or sleep timer, or go to the System settings menu (refer to chapter 13 "Using the Main menu" for details).

Showing FM information on the display

When listening to a FM radio station that is also broadcasting RDS data (the RDS icon is shown in the bottom bar of the radio's display), repeatedly press the Info button to cycle through the following information on the radio's display:

- Text message
- Program type
- Frequency
- Today's Date

If no RDS information is available, the radio will only be able to show Today's Date.

Storing and recalling preset stations in the FM radio mode

The WFR-28BT features 5 memory presets for FM radio. After selecting the FM radio mode, the procedure for storing and recalling preset stations in the FM radio mode is identical to the procedure in the DAB radio mode. Please refer to the instruction in the previous chapter for details on how to store and recall preset stations.

10. Listening to Bluetooth audio

In order to stream Bluetooth music to your radio, you need to pair your Bluetooth device with the WFR-28BT. Pairing creates a 'bond' so two devices can recognize each other.

Pairing your Bluetooth device for the first time

1. Turn on the radio using the Power button.
2. Select the Bluetooth mode by repeatedly pressing the Mode button or using the radio's Main menu. After selecting the Bluetooth mode, the radio's display will show the Bluetooth logo with the text **[No connect]** and you will hear a sound.
3. Activate Bluetooth on your Bluetooth device (refer to the manual of the Bluetooth device if you are unsure about how to activate Bluetooth).
4. Go to the Bluetooth list on your Bluetooth device and select the device named "WFR-28BT" (if you have changed the name of the radio in the radio's System settings menu, search for the name you have given the radio instead).

Note:
On some Bluetooth devices with Bluetooth version 2.1 or earlier, you might be requested to enter a passcode. If this is the case, enter the passcode "0000".

5. After the devices have paired and connected, a confirmation tone will be played on the radio. The radio will show the playback progress on the display and a Bluetooth icon will be shown in the bottom bar of the radio's display. You can now play music on your Bluetooth device and stream the music through the radio's speaker.

Notes:

- If 2 Bluetooth devices are pairing for the first time, both must search for your radio, it will show its availability on both devices. However, if one device links with this unit first, then the other Bluetooth device won't find it on the list.
- If you take your Bluetooth device out of range, the connection between your device and the radio will be temporarily disconnected. Your radio will automatically reconnect if the Bluetooth device is brought back into range. Be aware that during the period of disconnection, no other Bluetooth device can pair or link with your radio.

- If "WFR-28BT" shows up in your Bluetooth device list, but your Bluetooth device cannot connect with it, please delete the item from your list and pair the Bluetooth device with the radio again following the steps described previously.
- The effective operation range between the radio and the paired Bluetooth device is approximately 10 meters (30 feet). Any obstacle between the system and the device can reduce the operational range.
- Bluetooth connectivity performance may vary depending on the connected Bluetooth device. Please refer to the Bluetooth capabilities of your device before connecting it to your radio. Not all features may be supported, depending on the Bluetooth device used.
- With some mobile phones, making / receiving calls, text messages, e-mails or any other activities unrelated to audio streaming may mute the Bluetooth audio streaming or even temporarily disconnect from your device. Such behavior is a function of the Bluetooth device and does not indicate a problem with your WFR-28BT.

Audio playback in the Bluetooth mode

When you have successfully connected your radio with the chosen Bluetooth device, you can start to play your music using the controls on the radio or your connected Bluetooth device.

1. After connecting a Bluetooth device, the playback status will be displayed at the bottom of the radio's display.
2. The volume can be adjusted both on the radio using the Volume + / - button and on the Bluetooth device using the volume control of the device.

Playback can be controlled both on the radio and on the Bluetooth device as well. When using the radio's controls:

- Press the Play / Pause button to start audio playback or to pause / resume playback.
- Press the Next or Previous button to go to the next or previous track.
- Press and hold the Next or Previous button to fast forward or rewind within a track and release the button when the desired point is reached.

Note:

Not all player applications or devices may respond to all of these controls.

Audio playback from a previously-paired Bluetooth device

The WFR-28BT can memorize up to 8 sets of paired Bluetooth devices, when the memory exceed this amount, the earliest device with which the radio was paired will be overwritten in the radio's memory.

If your Bluetooth device has paired with the WFR-28BT previously, the radio will still remember your Bluetooth device and attempt to reconnect with the device that was last connected. If the last connected Bluetooth device is not available, the radio will try to connect to the second last Bluetooth device.

The Bluetooth menu

You can open the Bluetooth menu by pressing the Menu button while the radio is in the Bluetooth mode.

The Bluetooth menu offers the following options:

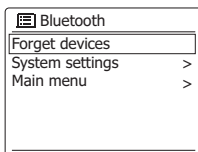

- **[Forget devices]:** Select this option to clear the list of devices the radio has previously paired with. If the radio is currently paired and connected to a device, the connection will be lost.
- **[System settings]:** Select this option to go to the System settings menu and configure the radio (refer to chapter 12 "Using the System settings menu" for details).
- **[Main menu]:** Select this option to go back to the Main menu, where you can switch to any of the radio's modes or set the radio's alarms or sleep timer, or go to the System settings menu (refer to chapter 13 "Using the Main menu" for details).

Disconnecting your Bluetooth device

To disconnect your Bluetooth device, either turn off Bluetooth on the Bluetooth device, press and hold Preset 2 button to switch over to the pairing mode (the Bluetooth icon in the bottom bar of the radio's display will blink), or switch to another mode on the radio by pressing the Mode button or by using the radio's Main menu. If you disconnect the Bluetooth device when the radio is in the Bluetooth mode, the radio's display will show the Bluetooth logo and **[No connect]** again and the radio will be available for pairing again.

Showing Bluetooth information on the display

When listening to Bluetooth audio, repeatedly press the Info button to cycle through the following information on the radio's display:

- Artist
- Album
- Title

11. The Aux in, Line out and headphones sockets

Listening to audio from an external device using the Aux in socket

You can listen to the audio of an external device (such as an iPod or MP3 player) through the speaker of the WFR-28BT. To do this, follow these steps:

1. Connect the external device to the Aux in socket using a 3.5mm audio cable (not included).
2. Make sure both the radio and the external device are turned on.
3. Select the AUX In mode by repeatedly pressing the Mode button or using the radio's Main menu.

4. The audio output of the external device will now be played through the speaker of the WFR-28BT. Playback must be controlled on the external device, while the volume can be controlled both on the radio and on the external device.

Output audio to an external device using the Line out socket

The WFR-28BT's audio can be output to an external device featuring an audio input socket (such as an amplifier featuring an Aux in socket). To do this, follow these steps:

1. Connect the radio's Line out socket to the audio input of the external device using a 3.5mm audio cable (not included).
2. Make sure both the radio and the external device are turned on.
3. Select the mode corresponding to the audio input on the external device.
4. Now audio that is being played on the radio will be heard through the external device. Playback must be controlled on the radio, while the volume can be controlled on the external device.
5. Press the Mute button to enable the mute feature and mute playback. Press the button again to disable the mute feature and continue normal playback.

Connecting a pair of headphones to the radio

Any headphones featuring a 3.5mm jack can be connected to the Headphones socket at the back of the radio. Simply connect the 3.5 mm jack of the headphones to the socket to start listening using headphones. After connecting headphones to the socket, the radio's speaker will be muted.

Important:
Excessive sound pressure from earphones and headphones can cause hearing loss.

To prevent possible hearing damage, do not listen at high volume levels for long periods.



12. Using the System settings menu

The System settings menu can be used to configure the WFR-28BT. Follow these steps to access the System settings menu:

1. Turn on the radio using the Power button.
2. Press the Menu button to open the menu for the current mode.
3. Rotate the Tuning knob to select **[System settings]** and press the Tuning knob to open the menu.

The System settings menu offers the following options:

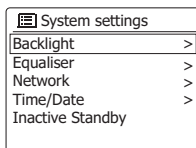

- **[Backlight]:** Select this option and then select **[Timeout]** to configure the time after which the backlight turns off, or select **[On level]** to adjust the display's brightness level when the radio is turned on.
- **[Equaliser]:** Select this option to choose one of the radio's equalizer modes (Flat, Rock, Pop, Jazz, Classic, News, Movie, or My EQ) or select the option **[My EQ profile setup]** to configure the bass and treble level and enable / disable the loudness feature for the My EQ equalizer mode.
- **[Network]:** Select this option to run the network wizard, run PBC setup, configure the radio's network connection, view and select available network profiles, or view or clear the network settings.
- **[Time / Date]:** Select this option to set the time and date manually, to set the source for automatically updating the time and date, or to and set the time format.
- **[Inactive Standby]:** Select this option to configure the time after which the radio automatically switches to the Standby mode when not being used.
- **[Language]:** Select this option to configure the language in which the radio's menus are shown.
- **[Factory reset]:** Select this option to reset the radio to the default factory settings. After confirmation, all user settings and preset stations will be erased.
- **[Software update]:** Select this option to configure whether the radio should occasionally check for available software updates or to check for available software updates.
- **[Setup wizard]:** Select this option to perform the Setup wizard again, either right away or at the next startup. Refer to chapter 3 "Getting started" for more information on using the Setup wizard.
- **[Info]:** Select this option to view the radio's Spotify version, Radio ID and Friendly Name.

If the **[Update from Network]** is selected under **[Auto update]**, the Time / Date submenu will also show the following two options:

- **[Set timezone]:** Select this option to configure the timezone.
 - **[Daylight savings]:** Select this option to enable or disable Daylight Savings Time (DST).
3. Select **[Set Time / Date]** and press Tuning knob to manually set the radio's time and date.
 4. The radio's display will show the time and date and the day digits are blinking on the display.
 5. Rotate the Tuning knob to select the current day and press the Tuning knob to confirm.
 6. Next, the month digits will blink on the display.
 7. Rotate the Tuning knob to select the current month and press the Tuning knob to confirm.
 8. Next, the year digits will blink on the display.
 9. Rotate the Tuning knob to select the current year and press the Tuning knob to confirm.
 10. Next, the hour digits will blink on the display.
 11. Rotate the Tuning knob to select the current hour and press the Tuning knob to confirm.
 12. Next, the minute digits will blink on the display.
 13. Rotate the Tuning knob to select the current minutes and press the Tuning knob to confirm.
 14. Manually setting the time is now completed and the radio will return to the Time / Date submenu.

Manually setting the time and date

Setting the radio's time and date works slightly different from configuring most of the other radio's options and features. If you would be unable to automatically update the time and date using the DAB, FM or network, follow these steps to manually set the time and date:

1. Open the System settings menu using the three steps previously described.
2. Select **[Time / Date]** and press the Tuning knob.

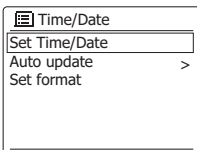

The Time / Date submenu offers the following options:

- **[Set Time / Date]:** Select this option to manually configure the time and date.
- **[Auto update]:** Select this option to select a source for automatically updating the time and date.
- **[Set format]:** Select this option to select the 12 or 24 hour format.

13. Using the Main menu

The Main menu can be used to select the radio's mode or to set the alarms and sleep timer of the radio. Follow these steps to access the Main menu:

1. Turn on the radio using the Power button.
2. Press the Menu button to open the menu for the current mode.
3. Rotate the Tuning knob to select **[Main menu]** and press the Tuning knob to open the menu.

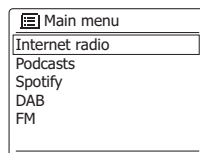

The Main menu offers the following options:

- **[Internet radio]:** Select this option to switch to the Internet radio mode.
- **[Podcasts]:** Select this option to switch to the Podcast mode.
- **[Spotify]:** Select this option to switch to the Spotify mode.
- **[DAB]:** Select this option to switch to the DAB radio mode.
- **[FM]:** Select this option to switch to the FM radio mode.
- **[Bluetooth]:** Select this option to switch to the Bluetooth mode.

- **[AUX in]:** Select this option to switch to the AUX in mode.
- **[Sleep]:** Select this option to set the radio's sleep timer.
- **[Alarms]:** Select this option to set the radio's alarms.
- **[System settings]:** Select this option to go to the System settings menu (refer to chapter 12 "Using the System settings menu" for more information on this menu).

Setting the alarms

Your WFR-28BT features 2 alarms that can be set using the **[Alarms]** option from the Main menu.

Follow these steps to set the radio's alarms:

1. Open the Main menu using the three steps previously described.

2. Select **[Alarms]** and press the Tuning knob.

Both alarms and their settings will be shown on the display:

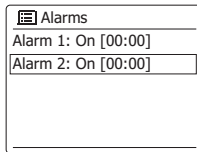

3. Rotate the Tuning knob to select the desired alarm and press the Tuning knob to confirm.

The submenu for configuring an alarm offers the following options:

- **[Enable]:** Select this option to configure the alarm frequency, the available settings here are **[Off]**, **[Daily]**, **[Once]**, **[Weekends]** and **[Weekdays]**.
- **[Time]:** Select this option to set the alarm time. This can be done in the same way as setting the time and date in the previous chapter.
- **[Mode]:** Select this option to set the mode that is used for the alarm.
- **[Preset]:** Select this option to select a preset station or the last listened station as the alarm source.
- **[Volume]:** Select this option to set the alarm volume.
- **[Save]:** Select this option to save the alarm settings.

4. Set all the first five of the above options using Tuning knob.

5. Select **[Save]** and press the Tuning knob. If an alarm is enabled, the corresponding alarm icon will be shown in the bottom bar of the radio's display if the radio is turned on and in the middle of the screen in the Standby mode.

6. To configure the other alarm, select this alarm in step 3 and repeat steps 4, 5.

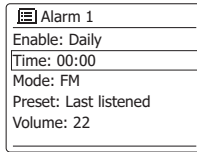

Notes:

- When an alarm sounds, press the Power button to turn off the alarm and switch the radio back to the Standby mode when the radio is connected to mains power or turn the radio off when using battery power. Repeatedly press any of the other buttons on the radio to snooze the alarm for the number of minutes displayed on the radio's display.
- After the snooze time is set, the remaining snooze time will be shown on the display when the radio is connected to mains power. If the radio is being used on battery power, only the set snooze time is shown on the radio's display and the displayed snooze time will not be updated. Snoozed alarms can be disabled by pressing the Power button.
- Alarms will stop sounding after 60 minutes have elapsed since the start of the alarm.

Setting the sleep timer

The sleep timer allows you to automatically turn off the radio after a preset time has elapsed. It can be set from 15 to 120 minutes using the **[Sleep]** option from the Main menu.

Follow the steps below to set the sleep timer using the radio's Main menu:

1. Open the Main menu using the three steps previously described.

2. Select **[Sleep]** and press the Tuning knob.

3. Rotate the Tuning knob to select the desired sleep time.

4. Press the Tuning knob or wait several seconds to enable the sleep timer with the selected time.

5. After the sleep time has elapsed, the radio will automatically switch to the Standby mode. When a sleep timer is active, a sleep timer icon and the remaining sleep time will be shown in the bottom bar of the radio's display.

6. To cancel the sleep time before the preset time has elapsed and to turn off the radio, press the Power button to turn off the unit manually. To cancel the sleep timer and leave the radio playing, go back into the sleep timer settings (steps 1 to 3 above) and select the option "Sleep OFF" in step 3.

Specifications

Power Requirements	
Power adapter	AC Input: 100-240 V ~ 50/60 Hz , 0.68A Max. DC Output: 9.0V / 1.2A , 10.8W
Battery	Input: 4 x D size (AM-1) Alkaline or NiMH batteries
Frequency Coverage	
FM	87.5-108 MHz
DAB	174.928-239.200 MHz
WiFi	802.11 b, g, n, a supported with WEP and WPA / WPA2 encryption. Compatible with 2.4GHz and 5GHz WiFi bands. The frequency and maximum transmitted power: WiFi: 2412MHz ~ 2472MHz, EIRP=12.10dBm 5180MHz ~ 5240MHz & 5745MHz ~ 5825MHz, EIRP=12.39dBm Operations in the 5.15-5.35GHz band are restricted to indoor usage only.
Bluetooth	
Bluetooth profiles	A2DP, AVRCP
Bluetooth codecs supported	SBC, AAC
The frequency and maximum transmitted power	2402MHz ~ 2480MHz: -0.57dBm (Bluetooth EDR) 2402MHz ~ 2480MHz: -0.67dBm (Bluetooth LE)
Circuit features	
Loudspeaker	76.2mm
Output power	2.5Watts
Headphone socket	3.5mm diameter, stereo
Aux In socket	3.5mm diameter, stereo
Line Out socket	3.5mm diameter, stereo
Aerial System	Built-in WiFi antenna
	DAB Telescopic aerial
	FM Telescopic aerial
Temperature operation	0°C ~ 35°C
Information on Power Consumption	
Power standby	The device has a standby mode with a power consumption of less than 0.8W.
Bluetooth mode	In Bluetooth mode, when there is no signal output, the idle power consumption is 2W after 15 minutes.
AUX mode	In AUX mode, when there is no signal output, the idle power consumption is 0.8W after 15 minutes.

※ The barcode label on the product is defined as below:

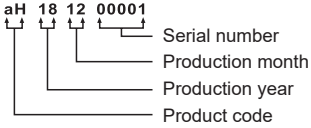
	 <p>Serial number Production month Production year Product code</p>
---	--

Sangean reserves the right to amend the specifications without notice.

 RECYCLING This product bears the selective sorting symbol for Waste electrical and electronic equipment (WEEE). This means that this product must be handled pursuant to European directive 2012/19/EU in order to be recycled or dismantled to minimize its impact on the environment.